

User's Manual

for

LTC - 21 Temperature Controller

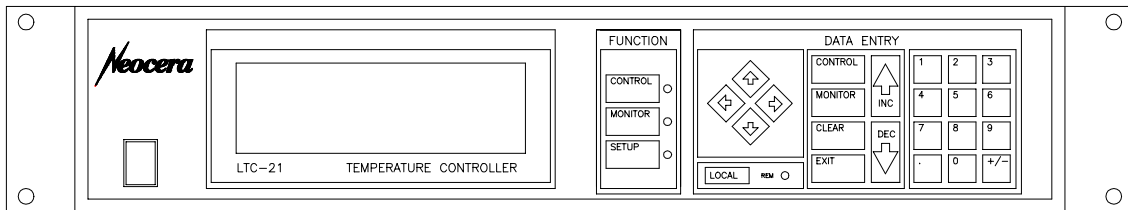

By:

Neocera

Instrument and Systems Group
Beltsville, Maryland
USA

© copyright 1999

NEOCERA, Inc. Part Number 3000-140

Revision Record		
Date	Revision	Description
May 21, 1997	A	Initial Release
October 1, 1997	B	First Neocera Release
August 19, 1999	C	Revised QRMP & SRMP

© 1999 by **NEOCERA Instrument and Systems Group**

All rights reserved. No part of this manual may be reproduced, stored in a retrieval system, or transmitted in any form or by any means, electronic, mechanical, photocopying, recording, or otherwise, without prior written permission of NEOCERA Inc.

NEOCERA Inc. reserves the right to change the functions, features, or specifications of its products at any time, without notice.

Any questions or comments in regard to this product and other products from NEOCERA Instrument and Systems Group., please contact:

<p>NEOCERA INC. Instrument and Systems Group 10000 Virginia Manor Road, Suite 300 Beltsville, Maryland 20705-4215 U. S. A.</p> <p>Customer Service and Technical Support: 1 (800) 290 - 4322 (Within U.S.A.) 1 (301) 210 - 1010 (Outside U.S.A.) Fax: 1 (301) 210 - 1042</p>

Cernox™ , ThermOx™ are registered trademarks of Lakeshore Cryotronics Inc.

WARRANTY

NEOCERA Limited Warranty

NEOCERA Inc. warrants this product for a period of twelve (12) months from date of original shipment to the customer. Any part found to be defective in material or workmanship during the warranty period will be repaired or replaced without charge to the owner. Prior to returning the instrument for repair, authorization must be obtained from NEOCERA Inc. or an authorized NEOCERA service agent. All repairs will be warranted for only the remaining portion of the original warranty, plus the time between receipt of the instrument at NEOCERA and its return to the owner.

This warranty is limited to NEOCERA'S products that are purchased directly from NEOCERA, its OEM suppliers, or its authorized sales representatives. It does not apply to damage caused by accident, misuse, fire, flood or acts of God, or from failure to properly install, operate, or maintain the product in accordance with the printed instructions provided.

This Warranty Is In Lieu Of Any Other Warranties, Expressed Or Implied, Including Merchantability Or Fitness For Purpose, Which Are Expressly Excluded. The Owner Agrees That NEOCERA'S Liability With Respect To This Product Shall Be As Set Forth In This Warranty, And Incidental Or Consequential Damages Are Expressly Excluded.

Warnings

WARNING:

TO PREVENT SHOCK AND FIRE HAZARDS, AS WELL AS DAMAGE TO THE LTC-21, IT SHOULD NOT BE ALLOWED TO GET WET OR OPERATE IN A CONDENSING ATMOSPHERE.

WARNING:

Never attempt to operate the LTC-21 at a different input line voltage than is shown on the power input module on the rear panel. Serious injury or equipment damage may result.

WARNING:

ALWAYS REPLACE THE FUSE WITH THE CORRECT VALUE TO PREVENT SHOCK AND FIRE HAZARDS, AS WELL AS DAMAGE TO THE LTC-21.

WARNING:

TO PREVENT SHOCK AND FIRE HAZARDS, ALWAYS CONNECT THE POWER CORD TO A THREE-CONDUCTOR, GROUNDED RECEPTACLE.

WARNING:

WITH PROPER VENTILATION, THE LTC-21 IS DESIGNED TO OPERATE INDEFINITELY WITHOUT DAMAGE TO ITSELF IF ITS HEATER OUTPUT IS SHORT CIRCUITED. HOWEVER, CARE SHOULD BE TAKEN TO AVOID THIS CONDITION SINCE THE 50 WATT OUTPUT COULD DAMAGE OTHER COMPONENTS OR RESULT IN A FIRE HAZARD.

WARNING:

IF THE INSTRUMENT IS USED IN A MANNER NOT SPECIFIED BY THE MANUFACTURER, THE PROTECTION PROVIDED BY THE EQUIPMENT MAY BE IMPAIRED.

Definition of international symbols for warnings and hazards.

CAUTION, RISK OF ELECTRICAL SHOCK

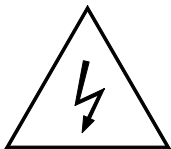

REFER TO ACCOMPANYING DOCUMENTS

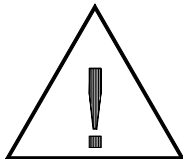

PROTECTIVE EARTH GROUND



Table of Contents

Warnings.....	iv
Definition of international symbols for warnings and hazards.....	v
1. Introduction.....	1
1.1. Features.....	1
1.2. Specifications.....	4
1.2.1. Input Channel Specifications.....	4
1.2.1. Output Specifications.....	5
1.2.2. Accuracy Specifications.....	8
1.2.3. Relay and Alarm Outputs.....	9
Relay Outputs.....	9
Audible Alarm.....	9
1.2.4. Remote Interfaces.....	9
IEEE-488 Interface.....	9
RS-232 Interface.....	9
1.2.5. Mechanical, Form Factors.....	9
1.2.6. Power.....	10
1.2.7. Environmental.....	11
2. Installation.....	13
2.1. Unpacking And Inspection.....	13
2.2. Rear Panel Layout.....	13
2.3. Power Requirements.....	14
2.3.1. Fuse.....	15
2.3.2. Grounding And Shielding.....	15
2.4. Heater Connection.....	15
2.4.1. Heater Wiring.....	15
2.4.2. Heater Selection.....	16
2.4.3. Analog Output Connection.....	17
2.5. Sensor Connection.....	17
2.6. Relay Connection.....	18
2.7. Interface Connection.....	18
2.8. Mounting The LTC-21.....	18
3. Operation.....	19
3.1. Use of the Keyboard.....	19
3.2. LOCAL Key.....	19
3.3. FUNCTION Keys.....	19
3.3.1. CONTROL.....	19
3.3.2. MONITOR.....	19
3.3.3. SETUP.....	19
3.4. DATA ENTRY Keys.....	19
3.4.1. Cursor Keys.....	19
3.4.2. INC (Increment) and DEC (Decrement) Keys.....	19
3.4.3. Numeric Keypad.....	20

- 3.4.4. BACKSPACE 20
- 3.4.5. CLEAR 20
- 3.4.6. ENTER 20
- 3.4.7. EXIT 20
- 3.5. Special Key Assignments 20
- 3.6. Menu Tree 21
- 4. Initial Power Up Sequence And Display 23
- 5. Operating Modes 25
 - 5.1. Introduction To The Three Operating Modes 25
 - 5.2. Monitor Mode: Monitoring Temperature With The LTC-21 25
 - 5.2.1. Using the Monitor Mode. 25
 - 5.2.2. Changing the SET POINT 26
 - 5.2.3. Relays and Alarms in Monitor Mode 27
 - 5.2.3.1. Control Mode: Regulating Temperature With The LTC-21 27
 - 5.3. Setup Mode: Configuring The LTC-21 28
 - 5.3.1. Introduction To The Setup Mode 28
 - 5.3.2. Instrument Setup Selection Menu 29
 - 5.3.3. Display Configuration Menu 30
 - 5.3.4. Set Display Units Menu 30
 - The Effects of Changing Display Units 30
 - Input Filter Time Constant Menu 31
 - 5.3.5. Datalog 32
 - 5.3.6. Sensor Configuration Menu 32
 - 5.3.7. Output Configuration Menu 33
 - Introduction to Configuring the Outputs .. 33
 - SENSOR Menu Field 34
 - MODE Menu Field 34
 - MAX PWR Menu Field 39
 - Ramp Menu Field 39
 - 5.3.8. Misc Menu 40
 - 5.3.8. Alarm & Relay Set Points 40
 - 5.3.9. Remote I/O Config. 41
 - 5.3.10. Sensor CAL Tables 42
 - 5.3.11. Entering a New Sensor Table 42
 - 5.3.12. Viewing and Editing a Sensor Table 46
 - 5.3.13. Deleting a User Table 47
 - 5.3.14. The Instrument Calibration Menu 48
 - 5.3.15. Input / Output Tests Menu 48
- 6. PID Theory And Tuning Tips 51
 - 6.1. The LTC-21 PID Mode 51
 - 6.2. Selecting Coefficients 51
 - 6.3. Fine Tuning the Coefficients 52
 - 6.4. Ramping 52
- 7. Using Autotune 55

Model LTC-21 Cryogenic Temperature Controller

7.1. Introduction.....	55
7.2. AUTOTUNE Basics.....	55
7.3. Advanced Usage of AUTOTUNE.....	57
8. Using Data Log.....	59
8.1. Introduction.....	59
8.2. DATA LOG Function.....	59
8.2.1. DATA LOG SETUP.....	59
Sample Interval field.....	60
Sensor Channel field.....	60
Total Samples/Channel field.....	60
Acquisition Mode field.....	60
Current Time field.....	61
8.3. Display Datalog.....	61
9. Model LTC-21 Functional Description.....	63
9.1. Block Diagram.....	63
9.2. Operation.....	65
10. Instrument Adjustments, Self Test and Calibration Procedures.....	67
10.1. Display Contrast Adjustment.....	67
10.2. Backdoor Modes.....	67
10.2.1. Clearing Non-Volatile RAM.....	67
10.2.2. Entering Instrument Recalibration Mode.....	68
10.3. Self Test.....	68
10.3.1. LED Tests.....	68
10.3.2. Analog Output Channel Tests.....	68
10.3.3. Heater Output Channel Tests.....	69
10.4. Heater Power Output Channel Calibration.....	69
10.5. Checking Sensor Calibration.....	70
10.6. Calibration Procedure, Sensor Channels.....	71
Appendix A: Remote Interface Commands:.....	73
*CLS.....	76
*OPC.....	76
*RST.....	77
*SRE.....	77
*WAI.....	77
IEEE Query Command Reference.....	78
*ESE?.....	78
*ESR?.....	78
*IDN?.....	78
*OPC?.....	79
*SRE?.....	79
*STB?.....	79
LTC-21 Commands Reference.....	80
SACONT.....	80
SADDR.....	80
SARTBL.....	80

Model LTC-21 Cryogenic Temperature Controller

SCALT	81
SCONT	82
SDLC	82
SDLI	82
SDLM	83
SDLS	83
SDLT	83
SDUR	83
SETP	84
SHCONT	84
SHMXPWR	85
SLLOCK	85
SMON	86
SOSEN	86
SPID	86
SPTBL	87
SPTBNDX	87
SRMP	87
STOD	87
SSTYPE	88
STUNE	89
STUNEP	89
SUERREG	90
SUNIT	90
DCALT	91
QADDR?	91
QARTBL?	91
QDLB?	92
QDLC?	93
QDUR?	94
QHEAT?	94
QISTATE?	94
QLLOCK?	95
QOUT?	95
QPID?	96
QPTBNDX?	96
QRMP	96
QSAMP?	96
QSETP?	98
QSTYPE?	98
QTBL?	99
QTOD?	99
QTUNEP?	100
QUERREG?	100
QUNIT?	100
Appendix B: IEEE 488.2 Example Programs	103

Model LTC-21 Cryogenic Temperature Controller

Appendix C: Interface Connector Pinouts..... 107
 Relays..... 107
 Sensors..... 107
 Analog Output:..... 110
 Heater:..... 110
Appendix D: Application Notes..... 111
 Procedure to interface with LTC-21 using Windows 3.1
 Terminal..... 111
 Procedure to Transfer Datalogged data to PC using
 PROCOMM for DOS..... 117
INDEX..... 119

Table of Tables

Table 1	Sensor Accuracy vs Sensor Excitation	8
Table 2	ac Fusing	15
Table 3	Conditions for Linear Operation of Heater	16
Table 4	LTC-21 Supported Sensors	33
Table 5	Output Configuration Options	34
Table 6	PID Modes	36
Table 7	Misc Menu Selections	40
Table 8	Relay Connector Pin Assignment	41
Table 9	Excitation/Accuracy/Resistance Range	43
Table 10	Sensor Type Selection	44
Table 11	Cal Table Units	44
Table 12	Autotune Process Time	57
Table 13	Datalog Configuration Selections	60
Table 14	IEEE Remote Interface Commands	75
Table 15	IEEE Analog Output Channel Control Information	80
Table 16	IEEE Sensor Calibration Selections	81
Table 17	IEEE Heater Output Channel Control Mode Selection .	84
Table 18	IEEE Maximum Heater Output Selection	85
Table 19	IEEE Sensor Type Selection	88
Table 20	IEEE SUERREG Command Error Register Bit Definition	90
Table 21	IEEE SUERREG Execution Error Register Bit Definition	90
Table 22	IEEE Standard Cal Table/Sensor Type Indices	98
Table 23	IEEE Standard and User Tables Contents	99
Table 24	QUERREG? Command Error Register Bit Definition ...	100
Table 25	QUERREG? Execution Error Register Bit Definition .	100
Table 26	Relay Connector Pin-out	107
Table 27	Sensor Connector Pin-out	109
Table 28	CryoCal™ Silicon Diodes Wire Color Codes	110
Table 29	Analog Output Pin-out	110
Table 30	Heater Connector Pin-out	111
Table 31	RS-232 Settings	112

Table of Figures

Figure 1	Four-Wire Sensor Connection.....	5
Figure 2	Heater Connection.....	6
Figure 3	LTC-21 Rear Panel.....	14
Figure 4	Menu Tree.....	21
Figure 5	ADC Calibration Screen.....	23
Figure 6	Monitor Mode Screen.....	26
Figure 7	Setpoint Screen.....	27
Figure 8	Control Mode Screen.....	28
Figure 9	Setup Screen.....	29
Figure 10	Display Configuration Screen.....	30
Figure 11	Display Units Screen.....	30
Figure 12	Display Update Rate Screen.....	31
Figure 13	Sensor Configuration Screen.....	32
Figure 14	Output Configuration Screen.....	33
Figure 15	PID Mode Screen.....	35
Figure 16	Table Mode Screen.....	37
Figure 17	Ramp Configuration Menu.....	39
Figure 18	Misc Menu Screen.....	40
Figure 19	Alarm & Relay Setup Screen.....	41
Figure 20	Remote Input/Output Configuration Screen.....	42
Figure 21	Sensor Parameters Screen.....	42
Figure 22	Sensor Calibration Edit/View Screen.....	45
Figure 23	Sensor Cal Table Menu Screen.....	47
Figure 24	Input/Output Tests Menu Table.....	48
Figure 25	Datalog Configuration Screen.....	59
Figure 26	Datalog Display Screen.....	61
Figure 27	LTC-21 Functional Block Diagram.....	63
Figure 28	LTC-21 Sensor Calibration Fixture.....	71
Figure 29	Platinum Sensor Four-wire Connection.....	109
Figure 30	DT-470 Sensor Four-wire Connection.....	109

Chapter 1

Introduction and Specifications

1. Introduction

1.1.Features

The LTC-21 is a high-performance temperature controller designed for use with most cryogenic temperature sensors. It has a wide range of features and capabilities that allow it to outperform competitive models in nearly every application. The LTC-21 is designed to accommodate the use of unusual sensors with higher resolution at ultra-low temperatures.

The LTC-21 features include:

Two, Multi-Purpose Inputs — The standard input modules supplied with the LTC-21 support all common cryogenic sensors, including:

- Silicon and GaAlAs diodes (from 1 K to about 400 K),
- Carbon, carbon-glass, ThermOx™, Cernox™, Ruthenium Oxide and germanium resistors (from less than 0.3 K to about 300 K),
- Platinum and RhFe RTDs of any resistance (from about 12 K to 500 K).

Digital control

The LTC-21 temperature controller is based on a fast, 32-bit microprocessor that uses advanced digital signal processing techniques to implement a completely digital temperature control loop.

Accurate

Use of high resolution Analog-to-Digital (20-bit) converter on all input channels and Digital-to-Analog (16-bit) converter on output channels ensures accuracy and smooth, continuous control.

A high loop sample rate (16 Hz) completely prevents instability due to temperature aliasing and allows the use of digital filters to further improve both display and control accuracy.

Performing all internal arithmetic computations in 32-bit IEEE compatible floating point format ensures that no accuracy is lost due to computational errors.

Sensor data is interpolated based on sensor calibration tables using a Cubic Spline algorithm.

NIST Traceable Calibration

Factory instrument calibration performed to a NIST traceable standards.

Variable ac and dc Sensor Excitation

A wide range of dc and ac sensor excitations are possible. Diode sensors are biased with 10 μ Amp dc, constant-current excitation. Linear sensors such as Platinum (Pt) and Rhodium-Iron (RhFe) sensors can use ac or dc with the same range of excitation. ac constant-voltage excitation may be used with Carbon, Germanium, and other resistive sensors. Using this constant voltage excitation, the power dissipated in the sensor is kept at very low levels, minimizing any self-heating at low temperatures (high resistances). There are 7 constant voltage excitation outputs in the LTC-21; 10.0mV, 3.0mV, 1.0mV, 320 μ V , 100 μ V, 32 μ V , and 10 μ V peak-to-peak. This feature enables the instrument to measure resistances from 1 Ω to 1 M Ω with very low power dissipation.

Calibration Curves

Standard calibration curves are stored for several sensor types supplied by the major cryogenic sensor manufacturers, including *LakeShore™ Cryotronics™*, *Scientific Instruments™*, and *CryoCal™*. Up to 16 additional user defined curves may also be entered into non-volatile memory. There may be up to 149 points per table and they are easily entered from the front panel or downloaded over one of the two remote interfaces. The standard tables supplied can be easily modified to adjust for one or two or three point calibrations of your actual sensor.

Dual Heater Outputs

The LTC-21 has two standard outputs: A 50 Watt heater and an Analog Output. Each of the two input channels may be configured to control either heater output.

The 50 Watt heater is a Constant-Current-Source type that can output up to 1.0A at up to 50V. Constant current is used to ensure that the port is short-circuit protected. When used with a 50W heater element, the corresponding maximum output power will be 50W. This output also has four user selectable ranges so that 50W, 5W, 0.5W or 0.05W may be selected as the maximum output power.

The second output is the Analog Output channel. This is a voltage type output that can be configured as a monitor or as a low power heater. In either case, it will output a maximum of ± 12 V at up to 100mA.

When used as a monitor, the Analog Output can be connected to recording devices including chart recorders. In this mode, user specified offset and gain parameters are applied to input temperature data in order to generate an analog output voltage.

If the Analog Output is configured as a control heater, PID coefficients are applied to generate the output voltage level.

Remote Control: IEEE-488 and RS-232 Interface Ports.

The LTC-21 is designed for incorporation in automated systems using either IEEE-488 or RS-232 interface ports. Both ports are supplied as standard features. Full computer control of all front panel functions is possible. Sensors readings and instrument status can be read remotely using either or both ports.

Alarms

Both channels have audible alarms with user programmable high and low limits.

Relay Outputs

Relays are supplied on both channels with separately programmable, high and low temperature set points. They may be used to control external equipment based on temperature range. Relay contacts are rated at 0.5A, 30V_{rms} or 60V_{DC}.

Control Algorithms.

A wide range of control algorithms simplify regulation of even the most difficult cryogenic systems. The LTC-21 has three AUTOTUNE modes that can regulate the most difficult systems over wide temperature ranges with no operator intervention. Full manual control of PID coefficients is possible. PID tables are available to store optimized parameters vs. setpoint.

Control Set Points.

Regulation set points can be entered with 0.001 K resolution over the entire operating range and 0.0001K below 10K for all calibrated sensors. For uncalibrated sensors, or calibrated sensors that are displayed in ohms or volts, the Set Points can be entered with six-digit resolution.

Resolution and Accuracy.

The temperature resolution and accuracy of the LTC-21 are usually limited by the sensor. The limitations imposed by the LTC-21 are discussed in the Instrument Specifications section.

1.2. Specifications

1.2.1. Input Channel Specifications

There are two temperature sensor input channels, each of which can separately be configured to use any of the supported sensor types.

Types of Sensors Supported

Supported Sensors include:

- Silicon and GaAlAs diodes
- GRT's.
- Carbon-Glass and Carbon-Composite.
- Cernox™ Resistors
- Ruthenium Oxide Resistors
- Germanium Resistors
- Rhodium-Iron.
- Platinum RTDs (Alpha types and arbitrary resistance at 300 K).
 - ThermOx™ Resistance Sensors

Additionally, pre-loaded standard calibration curves are supplied for the following sensors:

- Pt (100, 1000)
- Si diode thermometers (Lake Shore, CryoCal, and SI standard curves).

Other types of sensors may be supported by entry of “user” Sensor Calibration tables. Tables may be loaded via the remote interface, or they can be entered from the front panel.

Excitation Current

Sensor excitation is provided by independent current sources. ac or dc excitation may be selected. Diode sensors are dc biased at 10 ma, and resistive- type sensors (Platinum, Rhodium-Iron, Ruthenium Oxide, etc.) can be dc biased at 1 ma or 10 μ a, depending on the resistance range of the sensor. Resistive sensors can also be ac biased with a selectable constant peak-to-peak voltage of 10 mV to 10 μ V at a minimum of 100na.

Input Voltage Ranges

Four input voltage ranges are provided on each input channel. They are described as follows:

- 6V Generally used for GaAlAs Diodes.
- 2V for use with Silicon Diodes.
- 0.25V for Platinum-type resistive sensors.
- 10 mV - 10 μ V for other resistive sensors.

Sensor Connections

Connection to the sensors will be made via connectors mounted on the back panel of the instrument. Pins are available for Four-wire connections to each sensor and the metal shell must be connected to the cable shield.

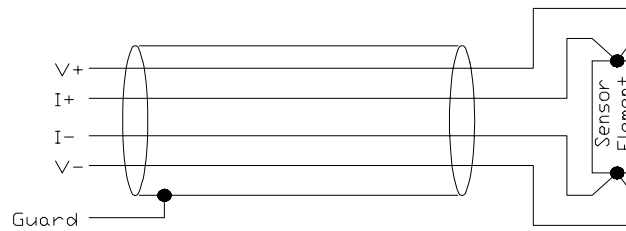

Figure 1 Four-Wire Sensor Connection

It is recommended that all sensors be connected using shielded, dual twisted pair cable as shown.

Calibration Curves

Eight calibration curves for various types of sensors are built into the LTC-21. Additionally, 16 user curves with up to 149 points each may be input via the front panel or remote interface.

User calibration curves are stored in non-volatile RAM, and will be retained for a period of 10 years.

1.2.1. Output Specifications

Heater Output.

The heater output provides up to 1 Ampere at 50 Volts. When using a 50 Ω heater, this corresponds to 50 Watts.

The heater output is a Constant Current Source drive and is short-circuit protected.

Output current has a resolution of 0.1%

There are four heater ranges to allow selection of a control range which closely matches system heat capacity. They are:

- Zero to 50W
- Zero to 5W
- Zero to 0.5W
- Zero to 0.05W

The LTC-21 heater is designed to have a load of 50 Ω , and it is strongly recommended that this value of heater resistor be used. The instrument assumes this load when displaying the heater power range on the front panel.

However, some users may want to use a 25 Ω heater and therefore a heater voltage switch is provided on the rear panel of the instrument to select between 50 Ω and 25 Ω heater resistors. When the 25 Ω heater is selected, the power range can be determined by dividing the displayed range by 2. The following ranges are available in the 25 Ω mode; 0.025W, 0.25W, 2.5W, 25W.

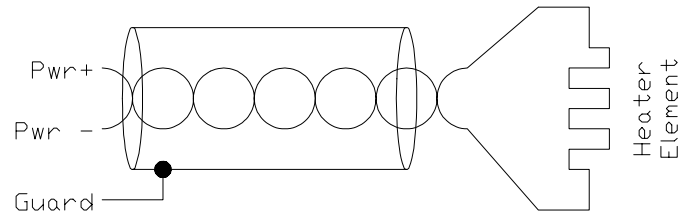

Figure 2 Heater Connection

Connection to the heater channel is provided by a 9-pin high-power connector mounted on the back panel of the instrument. Pins provide power, power return, and a shield ground.

Set-Point Resolution

Setpoints in the LTC-21 are maintained as 32-bit floating point numbers, ensuring at least six digit resolution.

Heater Feedback Type

The heater control algorithm is an enhanced digital PID type. The sample rate of the loop is 16 Hz so that sample rate aliasing is prevented. Enhancements to the standard PID control are:

- Loop output is converted into units of power, unlike most PID loops which output in volts or amperes. Therefore, the loop is linear with respect to the process variable, ensuring faster settling and better regulation. This is very important in cryogenic systems where the thermal load varies significantly with changes in temperature.
- Sensor inputs are converted to temperature first then used to update the control loop. Therefore, the gain of the loop is a constant and is independent from any non-linear characteristics of the sensor.
- Integrator “wind-up correction” is implemented so that rapid convergence is attained even with large changes in setpoint.
- To ensure accuracy, all computations are performed in IEEE-751 32-bit floating point. Output to the heater is done using a 16 bit DAC for 1 part in 65,000

resolution. All loop variables, including the set-point, are also in 32-bit floating point.

- High frequency damping is performed on the differentiator term so that effective use of this term can be allowed without instabilities caused by high frequency noise.
- Safety monitoring is implemented so that an open or shorted connection to the input sensor will be detected and will cause the control loop to be terminated and the heater to be turned off.

Heater Autotune Function.

The heater control has an Autotune function wherein the instrument will 'learn' the thermal characteristics of the system under control; then, generate appropriate PID coefficients required to efficiently control it.

Analog Output

A low power analog output channel provided. This output can be used as a linear output or as a second heater for temperature control of low-power systems.

Output voltage is ± 12 V with a maximum current of 100mA. This is a voltage output and over-current protection is NOT provided. Therefore, this output can be destroyed if connected to a low resistance load that will require an excess of 100mA.

Connection to the analog output channel is made via a 4-pin connector on the back panel. The connector housing provides a shield ground.

CAUTION

When using the analog output as a heater output, it is important to remember that at 0 power setting the output is not at 0 volts but can be as much as ± 100 mV.

The analog output may also be used to drive a user provided external power supply, resulting in a heater output ranging from 30W to kW.

Control Channel Configuration

Each output (Heater or Analog) may be assigned to either input channel independently. Therefore, all combinations of monitoring one channel and controlling another are allowed.

If the Heater output and the Analog output are configured for temperature control, the LTC-21 will maintain two completely separate control loops.

1.2.2. Accuracy Specifications

Display

Sensor data may be displayed in units of Kelvin, Fahrenheit, Celsius, Volts or Ohms.

- All displays are six digits plus sign, a floating decimal point and a units indicator.
- Time averaging may be performed by operator selection of intervals between 0.5 and 16 Seconds.

Accuracy of Sensor Measurements

The accuracy of linear resistance sensor measurements, including Platinum, Carbon-Glass etc. is 0.1% within the resistance range of 100 Ω to 1K Ω , 0.25% from 1K Ω to 10K Ω and 1% between 10K Ω and 30K Ω .

The accuracy of diode sensor measurements is 0.05%.

The accuracy of sensors using the variable ac constant voltage biasing is given in the following table:

Excitation	Accuracy	Resistance Range
1mV	0.1%	1 Ω to 1 M Ω
320uV	0.1%	1 Ω to 500 k Ω
	1%	500 k Ω to 1 M Ω
100uV	0.1%	1 Ω to 150 k Ω
	1%	150 k Ω to 1 M Ω
32uV	0.5%	1 Ω to 50 k Ω
	2%	50 k Ω to 500 k Ω
	10%	500 k Ω to 1 M Ω
10uV	0.5%	1 Ω to 15 k Ω
	2%	15 k Ω to 150 k Ω
	10%	150 k Ω to 1 M Ω

Table 1 Sensor Accuracy vs Sensor Excitation

All accuracy specifications are valid over the rated environmental temperature range.

Range of Temperature Measurements.

The instrument will measure and display temperatures in the range of 0K to 800K.

The actual temperature range for measurement is, of course, dependent on the type of sensor used.

Temperature Resolution

The temperature resolution of the LTC-21 is 1 part in 512000.

Maximum Frequency of Temperature Variation

The maximum frequency component of temperature variation that the LTC-21 can process is 5Hz.

1.2.3. Relay and Alarm Outputs

Relay Outputs

The LTC-21 has two relay outputs; one for each input channel. Both normally-open and normally-closed contacts are available on the rear panel.

The user may set the relays to open or close under specified conditions such as over or under temperature conditions.

Contacts are rated at 0.5A, 30V_{rms} or 60V_{DC}.

Audible Alarm

The LTC-21 has an audible alarm that may be configured by the user to sound on over and under temperature conditions on either input channel.

1.2.4. Remote Interfaces

IEEE-488 and RS-232 interfaces are both standard. All functions and read-outs available from the instrument may be completely controlled by either of the interfaces.

IEEE-488 Interface

The IEEE-488 interface allows complete remote control of the instrument as well as the ability to read all temperature information to full internal accuracy.

The interface is compliant with IEEE Standard 488-1978.

RS-232 Interface

The RS-232 interface allows full operation of the instrument, as does the IEEE-488 interface. The baud rate is selected by the front panel.

1.2.5. Mechanical, Form Factors

Front Panel

The front panel, including the display area is sealed membrane-type panel with the following characteristics:

- Large Vulcanized silicon-rubber tactile keypad.
- Super-Twist LCD display with LED type dc backlight.
- Power Switch (Rocker Switch).

Back Panel

The back panel interfaces are listed below:

- IEEE-488 Interface connector.
- Heater Output connector. Circular, AMP, 7-pin.
- 50 Ω /25 Ω Heater Selector Switch .
- Two Sensor Input Connectors, Circular Lemo, 4-pin.
- Analog Output Connector, AMP, 4-pin.
- RS-232 Connector, DB-9.
- Relay output connector. Circular, 8 pin.
- ac power entry module with fuse and voltage selector.

Enclosure

The LTC-21 enclosure is a standard full-width 19 inch rack-mountable type that may be used either stand-alone or incorporated in an instrument rack.

Bail

An instrument bail is provided standard.

Size

Enclosure size is 432mm wide x 89mm high x 337mm deep (17"x3.5"x13.25").

Rack Mount Use

The Rack mounting accessory package contains two front panel angle brackets that can be used to attach the instrument into a rack.

Weight

The LTC-21 weighs 7.1Kg.

1.2.6. Power

ac Power Requirements

The instrument will require single-phase ac power of 50 to 60 Hz. Voltages are selectable at the power entry module for 100/120 or 220/ 240 V_{ac} (tolerance $\pm 10\%$).

Power requirement is 126VA.

A low power cordset meeting the following minimum specifications is required for system operation.

North America: Low power (10A max), single phase, NEMA terminations, UL,CSA approvals.

EC countries: Low power (10A max), single phase, IEC-320 terminations, VDE approval.

Instrument Fusing

A user-replaceable 5x20mm fuse is mounted in the power entry module. This module also includes a spare.

A 5 x 20 mm 4 Amp normal blow fuse is required for 100 and 120 V_{ac} configurations and a 5 x 20 mm IEC 127 1.6 Amp time lag fuse is required for 220 and 240 V_{ac} configurations.

Power Grounding Requirements

The Ground wire on the ac line cord must be connected to a safety ground that does not normally carry electrical current. This safety ground becomes the Chassis Ground of the instrument and is used as the ground point for all cable shields. Thus, it is important to ensure a good quality connection.

1.2.7. Environmental

Maximum Safe Ambient Temperature Range

The Temperature Controller is designed to operate over an ambient temperature range of 0°C to 55°C without damage to the instrument. Depending on the sensor type and bias method used, accuracy specifications are only guaranteed over a more limited range as described in the following section.

Accuracy Ambient Temperature Range

The accuracy specifications for the LTC-21 are guaranteed over the following temperature range: 25° C ±5° C.

Humidity/Altitude

A normal laboratory environment is expected. Proper operation over extremes of altitude or humidity is not guaranteed.

WARNING:

To prevent shock and fire hazards, as well as damage to the LTC-21, it should not be allowed to get wet or operate in a condensing atmosphere.

Chapter 2

Installation and Setup

2. Installation

2.1. Unpacking And Inspection

Prior to unpacking the LTC-21, you should check the carton for any shipping damage. If damage is observed, notify the carrier immediately to allow for a possible insurance claim.

The following items are included with the LTC-21. If any items are missing, notify your NEOCERA representative immediately.

Packing List:

- LTC-21 Temperature Controller
- Fuses installed in the controller Power Entry Module
- ac Power Cord
- Users Manual
- Analog Output Connector Assembly
- Sensor Cable with mating connector, 5 meters
- Heater Connector Assembly
- Relay Connector Assembly
- CE Declaration of Conformance.
- CE Kit and Instructions.

2.2. Rear Panel Layout

The rear panel layout of the LTC-21 provides connections for the following functions:

- IEEE-488 Interface connector.
- Heater Output connector. Circular, AMP, 7-pin.
- Two Sensor Input Connectors, Circular Lemo, 4-pin.
- Analog Output Connector, AMP, 4-pin.
- RS-232 Connector, DB-9.
- Relay output connector. Circular, 8 pin.
- ac power entry module with fuse and voltage selector.

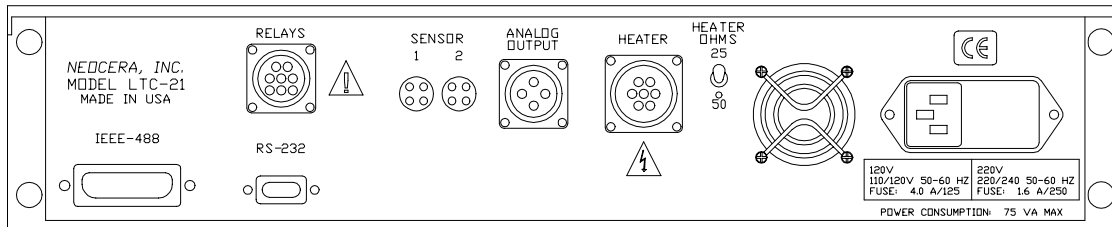

Figure 3 LTC-21 Rear Panel

2.3. Power Requirements

ac power can be provided to the LTC-21 at voltages of 100/120 or 220/240 Volts, 50 or 60Hz. These MUST be selected by the voltage selector which is part of the ac power entry module mounted on the rear panel of the instrument.

To change the power configuration perform the following steps:

- a) Disconnect the ac power cord from the instrument.
- b) Locate the ac input module on the rear panel. The ac power configuration can be seen in a small window in the fuse drawer.
- c) Push on the small locking tab on the fuse drawer and remove the fuse drawer.
- d) To change the ac input configuration, remove the switch block from the rear of the fuse drawer. Rotate the switch block until the desired ac input appears in the window of the fuse drawer.
- e) Install the fuse drawer into the ac input module and connect the ac power cord.

The LTC-21 will operate properly from either 50 or 60Hz ac power.

WARNING:

Never attempt to operate the LTC-21 at a different input line voltage than is shown on the power input module on the rear panel. Serious injury or equipment damage may result.

2.3.1. Fuse

The instrument fuse is located in the ac power entry module which is mounted on the rear panel of the instrument. This module also contains a spare fuse.

The LTC-21 requires the following fuses depending on the line voltage used:

ac Power	Fuse
100 - 120 V _{ac}	3 Amp normal blow
220- 240 V _{ac}	1.6 Amp time lag

Table 2 ac Fusing

WARNING:

Always replace the fuse with the correct value to prevent shock and fire hazards, as well as damage to the LTC-21.

2.3.2. Grounding And Shielding

The LTC-21 is equipped with a three-conductor power cord that connects the instrument chassis to earth ground.

WARNING:

TO PREVENT SHOCK AND FIRE HAZARDS, ALWAYS CONNECT THE POWER CORD TO A THREE-CONDUCTOR, GROUNDED RECEPTACLE.

Grounding and shielding of sensor and output lines are important considerations when using a low-noise instrument such as the LTC-21. The sensor inputs, the heater output and the analog output are all isolated from earth ground and are connected at one point to circuit ground inside the LTC-21.

2.4. Heater Connection

2.4.1. Heater Wiring

The Heater output is available on the rear panel at the labeled connector.

Connect your heater leads to the mating connector supplied. Care should be taken not to ground either heater lead. If this is not possible, ground the lead connected to pin 2.

WARNING:

WITH PROPER VENTILATION, THE LTC-21 IS DESIGNED TO OPERATE INDEFINITELY WITHOUT DAMAGE TO ITSELF IF ITS HEATER OUTPUT IS SHORT CIRCUITED. HOWEVER, CARE SHOULD BE TAKEN TO AVOID THIS CONDITION SINCE THE 50 WATT OUTPUT COULD DAMAGE OTHER COMPONENTS OR RESULT IN A FIRE HAZARD.

The wire size required in your cryostat depends on the maximum power that will be required. If 50 Watt power will be required, use 24 gauge, or heavier, stranded copper wires. Connect the heater to the positive (+) and negative (-) outputs. The earth ground should only be used for shielding.

Best performance will be achieved if the heater wires are run as twisted pairs which are physically separated from the sensor leads. Heater leads should never be connected to the sensor grounds.

2.4.2. Heater Selection.

The Heater output is driven by a current source with maximum capability of 1 Amp. This output is calibrated for use with a 50Ω heater which also allows the maximum output power of 50 Watts. Although the exact heater resistance is not critical, the use of a nominal 50Ω heater is strongly recommended. The LTC-21 will work with other heater resistances, but the output will no longer be calibrated. If a resistance other than 50Ω is used, the actual power may be calculated from the power indicated on the front panel using the following equation:

$$\text{Actual Power} = \text{Indicated Power} * (\text{Heater Resistance}) / 50$$

The voltage compliance of the current source is limited to about 50 volts. For this reason, full-scale linear operation is only possible under the following conditions:

Range	Maximum Heater Resistance
50 Watt	50Ω
5 Watt	160Ω
0.5 Watt	500Ω
0.05 Watt	1.6KΩ

Table 3 Conditions for Linear Operation of Heater

Use of a heater resistance value less than 50Ω provides linear operation under all conditions, but the output power is always less than indicated. For systems that require heater power substantially less 50 mWatt, it is possible to use a current divider having a 50Ω resistor at room temperature connected in parallel with a higher resistance heater attached to the system.

Some users may want to use a 25 Ω heater and therefore a heater voltage switch is provided on the rear panel of the instrument to select between 50 Ω and 25 Ω heater resistors. When the 25 Ω heater is selected, the power range can be determined by dividing the displayed range by 2. The following ranges are available in the 25 Ω mode; 0.025W, 0.25W, 2.5W, 25W.

2.4.3. Analog Output Connection

The Analog output port can be software-configured as either a 1 W (max) output for temperature regulation or as a calibrated analog output for monitoring temperature. The hardware connection is the same in either case.

The ground connection should only be used for shielded leads. The low side of this output may be grounded when using it to monitor temperature, but a differential measurement is usually preferred to avoid adding noise to the measurement. The low side should not be grounded when using the Analog output for temperature regulation. If this can not be avoided, it is essential that the low side be grounded at one point only and that it not be connected in common with the sensors.

The type of wire used to connect to the Analog output is usually not critical. Shielded, twisted, 24 gauge copper wire is commonly used inside the cryostat, but the exact choice depends on thermal requirements and electrical noise in your cryostat.

2.5. Sensor Connection

Sensors can be attached to the two labeled Sensor input connectors on the rear panel. A mating connector (Lemo Inc. FGG.1B.304.CNAD52) with attached shielded cable is supplied for use in attaching your sensor.

The LTC-21 is designed to make accurate readings, even in the presence of large interfering signals, such as power-line pick up. Nevertheless, it is always best to use properly designed input leads to minimize stray pick up. The sensor cable supplied with the LTC-21 has been carefully selected for low-noise operation. It comprises two, twisted pair cables inside a non-current carrying shield. If it is necessary to replace this cable, always use a cable of similar design. Additional or replacement connectors with attached cable are available from NEOCERA Instrument and Systems Group.

Wiring diagrams for various sensor types are shown in Appendix C. For best performance, all sensors should be connected in a four-terminal configuration. Polarity is critical with diode sensors, but generally unimportant with all other types. All four connections should be floating, but if it is necessary to ground any part of the sensor circuit, it must be the low (-) side. The ground connection should only be used for the sensor cable shield. The cable shield should be grounded at the connector. It is generally best NOT to ground the shield at the cryostat.

Optimum wire selection for use inside your cryostat depends on many factors. In all cases, it is best to make a four-wire connection using two sets of shielded, twisted pairs. The shield

should not be connected to the low side of the sensor leads. The shield ground should be attached to the sensor connector at the rear panel of the instrument. Special wire is available for sensor connection from a number of sources. In most cases, it is adequate to run two pair of twisted, 0.005" diameter leads inside your cryostat. Common choices of metal for these leads include phosphor-bronze, brass, and Manganin. Very high resistance leads (greater than 100 ohm per wire) should be avoided if possible. Low resistance (copper) leads work well so long as they do not conduct so much heat into the sensor as to cause erroneous readings.

After the sensor is connected, it is essential that the LTC-21 software be correctly configured for use with the installed sensor type.

2.6. Relay Connection

Each relay contact is rated at 0.5A, 30V_{rms} or 60V_{DC}.

The relay contacts will change state on all relays which are enabled if the temperature exceeds the assigned high or low limits.

2.7. Interface Connection

Connection to the IEEE-488 is via an industry standard IEEE-488 connector to the IEEE-488 connector on the rear panel.

Connection to the RS-232 is via a female DB-9 connector to the RS-232 connector on the rear panel.

2.8. Mounting The LTC-21

Bench Mounting

The LTC-21 is supplied ready for bench use. Plastic feet are supplied on the bottom of the instrument; these should not be removed as they allow for an air gap beneath the instrument which aids in cooling. The front of the instrument may be elevated for better viewing angle using the built-in tilt stand.

Rack Mounting

The LTC-21 may be rack mounted using the optional rack-mount kit available from NEOCERA Instrument and Systems Group. Simply attach the supplied ears to the sides of the LTC-21. The LTC-21 may then be mounted in any standard 19" rack-mount enclosure.

Chapter 3

Operation

3. Operation

3.1. Use of the Keyboard

All keys on the LTC-21 are programmed to provide a consistent result, regardless of the menu displayed.

Response of the LTC-21 to the various keys is summarized in the following sections.

3.2. LOCAL Key

Pressing the LOCAL key unconditionally terminates remote control of the LTC-21 via either the RS-232 or IEEE-488 port. This permits control via the front panel keys. The REMOTE indicator LED turns off to indicate this condition. All keys, other than the LOCAL key, are disabled if the REMOTE indicator LED is on.

3.3. FUNCTION Keys

3.3.1. CONTROL

Regardless of the menu currently displayed, pressing CONTROL causes the LTC-21 to enter the CONTROL mode and show the Normal Operating Display. Temperature regulation will begin immediately (or continue) if the LTC-21 is properly configured for temperature control.

3.3.2. MONITOR

Regardless of the menu currently displayed, pressing MONITOR causes the LTC-21 to enter the MONITOR mode and show the Normal Operating Display. Heater outputs are immediately and unconditionally disabled.

3.3.3. SETUP

Pressing SETUP calls up the MAIN SETUP MENU used to change the LTC-21 operating parameters. If the LTC-21 was previously in the CONTROL mode, it will continue to regulate temperature until a parameter is changed which effects one of the operating parameters of the control loop.

3.4. DATA ENTRY Keys

Entering data from the front panel is a straightforward process using the following keys:

3.4.1. Cursor Keys

The four, arrow-shaped cursor keys are used to make menu selections by moving the cursor (indicated by flashing text) around the display.

3.4.2. INC (Increment) and DEC (Decrement) Keys

The two keys labeled INC and DEC are used to scroll through the possible choices for a given item that has been selected using the cursor keys. The choices presented are usually

limited to those that are valid and the operator is warned of an invalid entry by the internal beeper. However, in some cases where items on different menus are interrelated, invalid choices may be allowed to simplify data entry by not forcing a particular sequence of entries. For this reason, it is a good idea to verify all instrument settings after a change has been made to any one of them.

3.4.3. Numeric Keypad

The 12 keys on the numeric keypad are only used when a numeric entry is required. If a numeric entry is not appropriate, these keys are automatically disabled.

3.4.4. BACKSPACE

The BACKSPACE key erases the last character entered from the numeric keypad.

3.4.5. CLEAR

The CLEAR key erases the entire entry from the numeric keypad and allows you to start over.

3.4.6. ENTER

The ENTER key is used to terminate the entry of data from the keypad. If you EXIT a menu without pressing ENTER, the previous data is restored and the new entry is lost.

3.4.7. EXIT

The EXIT key will unconditionally move you back up one menu (see Section 3.6, The Menu Tree). Pressing EXIT does not cause an implied ENTER, i.e. if data has been input but ENTER has not been pressed, it may be lost when EXIT is pressed.

3.5. Special Key Assignments

Occasionally, a key will be assigned a special usage other than that described above. If this is done, the display will always prompt the user and describe this special usage. For example, the ENTER key is used in the CONTROL and MONITOR modes to allow entry of a new temperature setpoint.

3.6. Menu Tree

LTC-21 functions are represented by the following menus.

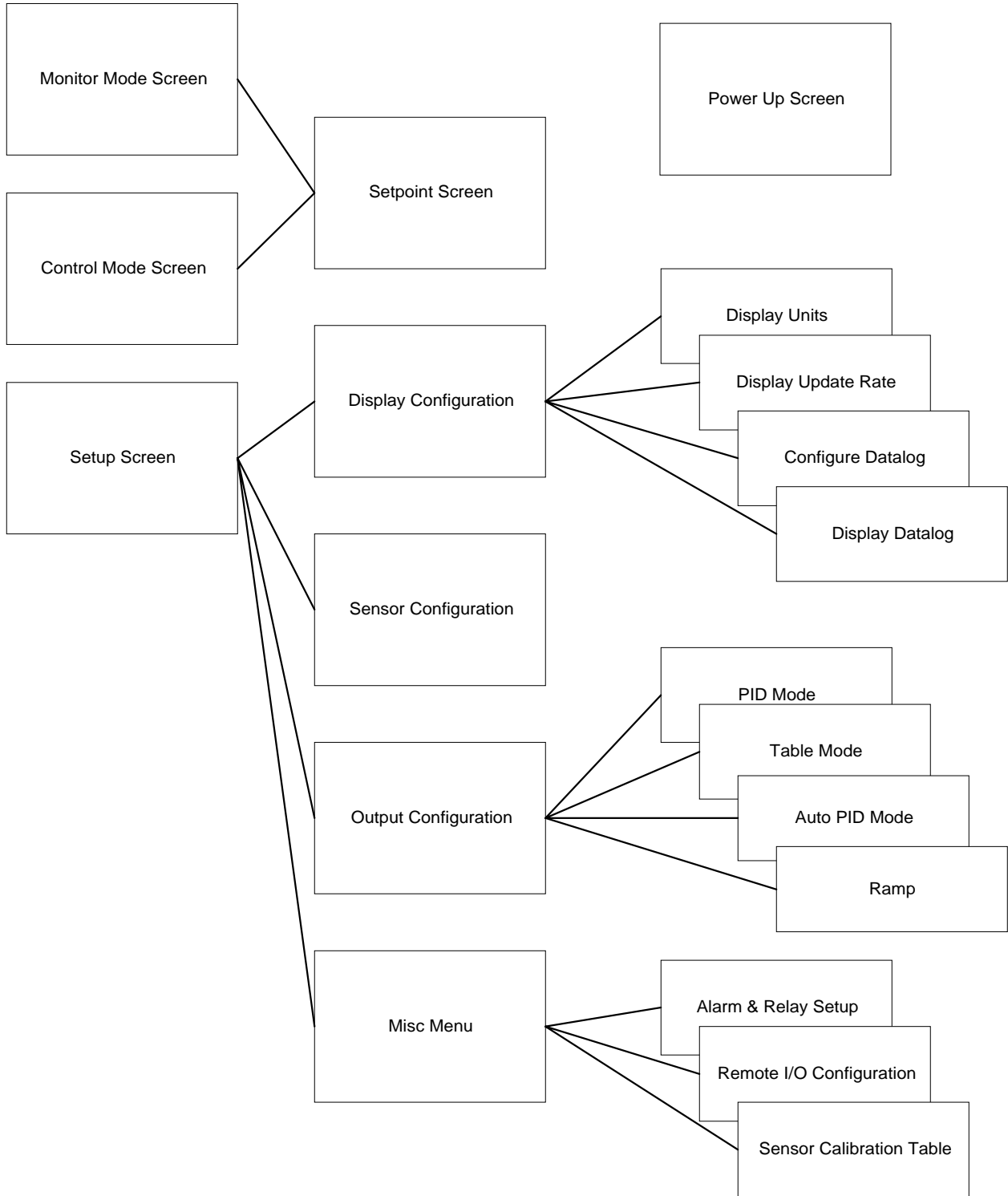

Figure 4 Menu Tree

Chapter 4

Initial Power Up

4. Initial Power Up Sequence And Display

When the LTC-21 is first powered up, it goes through a series of internal self-tests, then performs an internal ADC calibration. This is indicated by the display of "ADC Cal" (A/D Converter Calibration) in place of the measured temperature.

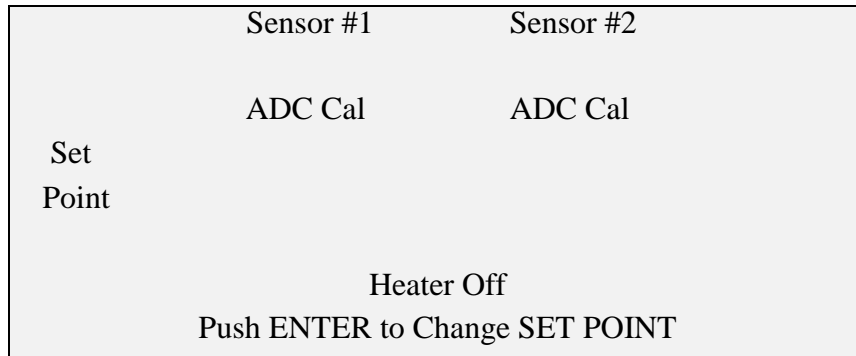

Figure 5 ADC Calibration Screen

After the calibration is complete, the LTC-21 enters the MONITOR mode and "ADC Cal" is replaced by the measured sensor value. This process requires approximately five seconds.

First Time Operation

As shipped from the factory, the LTC-21 is software configured to read and display the resistance (in Ohms) of a sensor connected to SENSOR #1 input. The interface is configured as an IEEE-488 port with address 15. SENSOR #2, the heater, analog output, relays and alarms are all disabled.

NOTE:

The LTC-21 performs an internal calibration on each sensor channel on power-up. To insure highest performance and accurate temperature readings, a temperature sensor must be attached to the SENSOR input channel you wish to monitor prior to power-up.

Chapter 5

Operating Modes

5. Operating Modes

5.1. Introduction To The Three Operating Modes

The LTC-21 has three distinct operating modes; the CONTROL, MONITOR and SETUP modes. These are accessed using the buttons in the FUNCTION section of the front panel. If the LTC-21 is in the LOCAL mode (REMOTE indicator LED turned off), pressing any of these buttons will immediately put the LTC-21 into the indicated operating mode, regardless of its current status.

- MONITOR — The monitor mode is used to monitor and display the temperature of calibrated sensors connected to the inputs. Uncalibrated sensors (and calibrated sensor, if desired), are displayed in their intrinsic units, i.e. Volts, Ohms, etc. Heaters are unconditionally disabled in this mode.
- CONTROL — The control mode is used when temperature regulation is desired. Heaters are enabled in this mode which is otherwise identical to MONITOR mode.
- SETUP — The setup mode is used to change any of the LTC-21 parameters with the exception of temperature SET POINT. If SETUP mode is selected from CONTROL mode, the LTC-21 will continue to regulate temperature unless a parameter is changed which effects one of the operating parameters of the control loop.

5.2. Monitor Mode: Monitoring Temperature With The LTC-21

5.2.1. Using the Monitor Mode.

The MONITOR mode is used to monitor the temperature of the sensors. The Heater output is disabled in this mode, so temperature regulation is not possible. The Analog output is also disabled if it is configured for controlling temperature ; if it is configured as a Monitor port, it will continue to function normally.

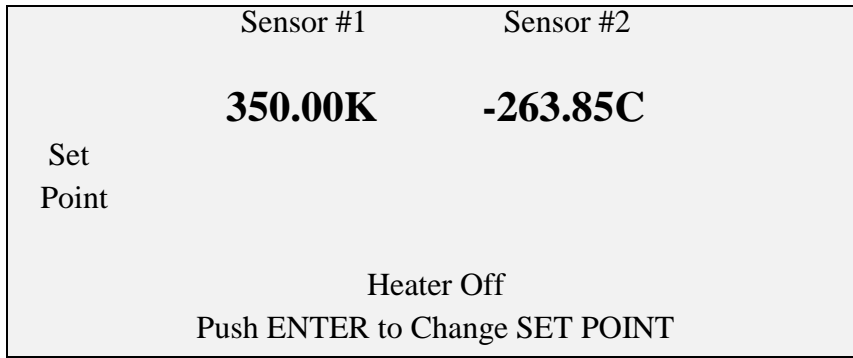

Figure 6 Monitor Mode Screen

Usually, the Normal Operating Display, will be presented in the MONITOR mode. The output of the sensors are displayed in large characters under the assigned SENSOR# (input number). If no sensor type has been assigned to an input, the display will be blank under the unassigned SENSOR#. If there is no sensor attached to the connector on the rear panel of the instrument, or if the sensor calibration has not been stored in the LTC-21, that channel may display “. . . K” or an erroneous reading. If no sensor is connected, please select “No Sensor” in the Sensor Configuration Menu (refer to Section 5.4.6).

5.2.2. Changing the SET POINT

The temperature SET POINT row of the Normal Operating Display will not be shown in the MONITOR mode since the heaters are disabled. Nevertheless, it is possible to change the stored SET POINT for both sensors by pressing ENTER to bring up the HEATER SETPOINT SELECTION display.

The Heater Set Point Display is a multi-functional display, showing most of the information regarding temperature control. The Heater and Analog set points are displayed in the center column of the screen. The actual temperature of the sensor assigned to the particular heater is displayed just to the right of the setpoints.

Below the heater information, the heater mode selection (PID, Auto PID, etc.) and actual heater power (% of range) is displayed.

The bottom of the screen displays the P, I, D, and PO values in effect for the Heater and Analog set points.

Heater Set Point Selection		
Heater Set Point	325.00K	305.000K
Analog Set Point	315.00K	300.000K
AUTO PID	46% of 0.5 W	
Heater P=	50	I= 25 D= 6 P0= 0.0
Analog GAIN =	1.00	OFFSET = 1.00
Press EXIT to return		

Figure 7 Setpoint Screen

To change to SETPOINT, move the cursor to the desired SETPOINT and use the numeric keypad to enter new values. Press ENTER to confirm the new entries. Press EXIT to return to the Main Operating Display. The new SET POINT will take effect when the CONTROL mode button is pressed.

5.2.3. Relays and Alarms in Monitor Mode

Relays and Alarms remain active in the MONITOR mode. To enable/disable them or to change their high/low limits, press the SET UP key and follow the directions given in Section 5.4.9. When this is done, the SETUP mode indicator LED will turn on. Note that the MONITOR mode indicator LED remains lit while you do this indicating that the LTC-21 is still in the MONITOR mode with Relays, Alarms, and the Monitor function of the Analog output still active.

The LTC-21 will leave the MONITOR mode if some critical configuration parameters, such as sensor type, are changed. In this case, the MONITOR indicator LED will turn off; relays, alarms, and analog output will be disabled.

5.2.3.1. Control Mode: Regulating Temperature With The LTC-21

The CONTROL mode regulates temperature and is identical to the MONITOR mode with the following exceptions:

- Heater output is enabled.
- Analog output is enabled (regardless of its configuration).

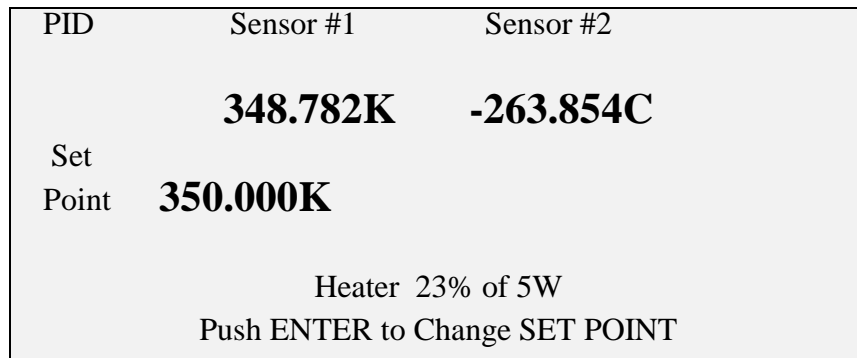

Figure 8 Control Mode Screen

The Normal Operating Display shows the following additional information in the CONTROL mode:

- The Heater MODE is displayed in the upper left-hand corner.
- The Heater power, as a percent of full scale, and the full scale range (i.e. "MAX PWR") are shown near the bottom of the display.
- The SET POINTs are displayed for any output that is currently active.

If a stored SET POINT value is not shown on the Normal Operating Display, the LTC-21 is not correctly configured to regulate temperature at this set point. You should check all of the following:

- The CONTROL indicator LED must be on (press CONTROL).
- A SENSOR # must be assigned to the output
- MAX PWR range must be a value other than "OFF" (the MAX PWR range is shown after HEATER % on the Main Operating Display).
- A Heater is connected to the HEATER OUTPUT (must not be open).

Changing SET POINT, or any other instrument parameter, is done as in the MONITOR mode. Most parameters can be changed without affecting temperature regulation. However, the LTC-21 will automatically terminate the CONTROL mode, disabling all heaters, if a parameter is changed that effects one of the operating parameters of the control loop. Changing the sensor assignment or the heater range are examples of such a change. If CONTROL mode is terminated, the CONTROL indicator LED will turn off.

5.3. Setup Mode: Configuring The LTC-21

5.3.1. Introduction To The Setup Mode

SETUP mode is used to configure all of the LTC-21's operating parameters, with the exception of temperature SET POINT (which is selected from either the MONITOR or

CONTROL mode by pressing ENTER). To enter the SETUP mode and display the INSTRUMENT SETUP SELECTION menu, simply press the front panel SETUP button. The SETUP mode indicator LED will turn on indicating that the LTC-21 is in the SETUP mode.

The LTC-21 will continue to regulate temperature if you enter the SETUP mode from the CONTROL mode. It will terminate CONTROL only if a setting is changed which makes regulation impossible or which effects one of the operating parameters of the control loop. For example, you may enter the SETUP mode to change display units without affecting temperature regulation. However, if you change the type of sensor assigned to the input, the LTC-21 will turn off the heater. The CONTROL mode indicator LED will turn off, indicating that you are no longer regulating temperature.

5.3.2. Instrument Setup Selection Menu

The INSTRUMENT SETUP SELECTION menu is displayed whenever the SETUP button is depressed.

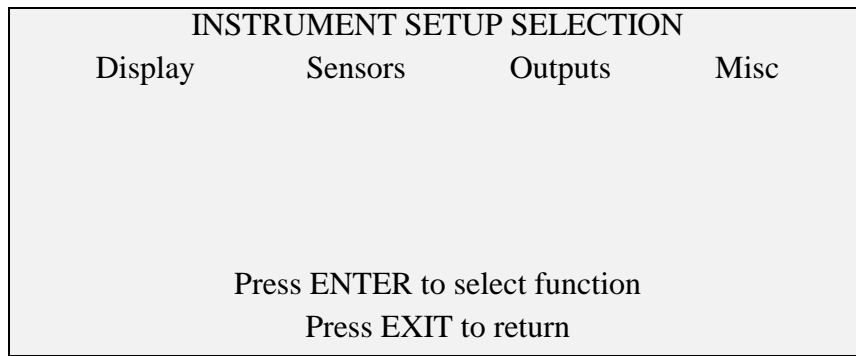

Figure 9 Setup Screen

The four selections shown on this menu (DISPLAY, SENSORS, OUTPUTS, MISC) call up submenus which can be used to change any of the LTC-21 operating parameters. Use the right and left cursor keys to highlight the desired choice, indicated by a flashing selection on the display, and press ENTER.

When first configuring the LTC-21, it is a good idea to go through all selections from left to right on this menu to display, select, and verify all the possible choices.

5.3.3. Display Configuration Menu

Choosing DISPLAY from the INSTRUMENT SETUP SELECTION Menu calls up the DISPLAY CONFIGURATION menu.

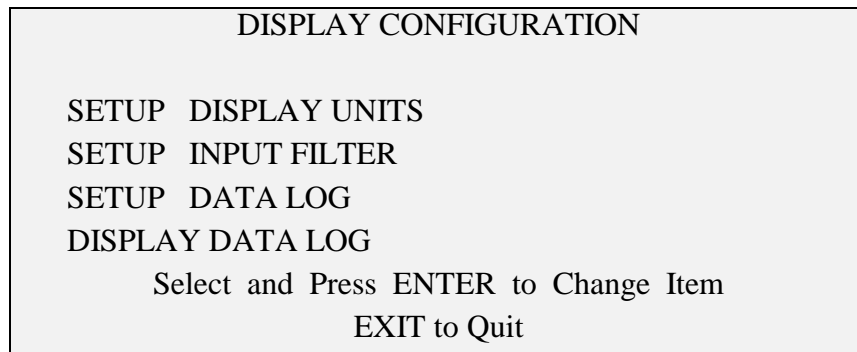

Figure 10 Display Configuration Screen

5.3.4. Set Display Units Menu

Choosing SETUP DISPLAY UNITS from the DISPLAY CONFIGURATION Menu calls up the SETUP DISPLAY UNITS menu. Use the cursor keys to choose the desired SENSOR # and then select the desired units using the INC and DEC keys. Return to any operating mode by pressing the appropriate front panel button or return to the INSTRUMENT SETUP SELECTION menu using EXIT.



Figure 11 Display Units Screen

Note that it is possible to select units that are not appropriate for the currently assigned sensor, e.g., Ohms can be selected for diode sensors and Kelvin can be selected for uncalibrated sensors (This is done to simplify entry of data for new sensors). It is left to the operator to assure that the selected units are appropriate for the sensor.

The Effects of Changing Display Units

Changing display units has a global effect on all displays. For example, if SENSOR #1 is displayed in Kelvin, the set points for all relays assigned to this sensor will be displayed in Kelvin.

Changing display units between different temperature units only affects the display; it has no effect on the operation of the LTC-21. However, if you change from temperature units (Kelvin, Fahrenheit, or Celsius) to fundamental sensor units (ohms or volts), the unit will

leave the CONTROL mode. Changing between fundamental units or from fundamental to temperature units has the same effect. This happens because the LTC-21 regulates temperature using the displayed units to determine the error signal (i.e., If ohms are displayed, the regulation is based on the difference in ohms between the measured sensor resistance and the set point. If temperature units are displayed, the LTC-21 calculates the error signal in Kelvin). This is done to provide a much more linear system response when using nonlinear sensors.

Input Filter Time Constant Menu

From the DISPLAY CONFIGURATION Menu, the user may enter the SETUP INPUT FILTER TIME CONSTANT menu. Use the INC and DEC key to change the input filter time constant of 0.5sec, 1 sec, 2 sec, 4 sec, 8 sec, and 16 seconds.

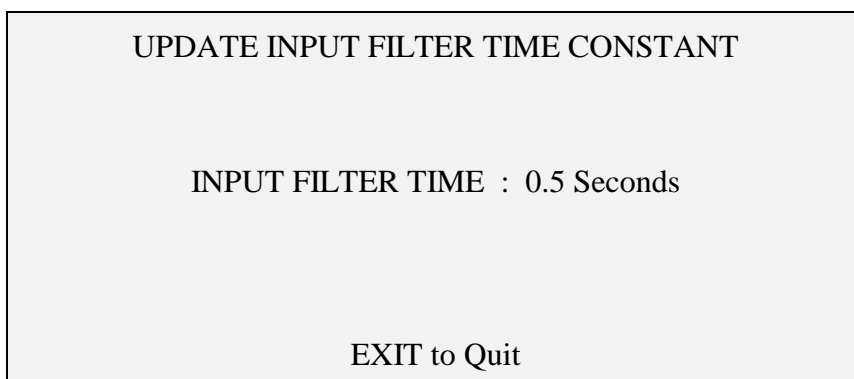

Figure 12 Display Update Rate Screen

Displayed temperature data is refreshed every 0.5 seconds regardless of the Input Filter Time setting. Further, the input sensors are always sampled 16 times per second. The data displayed will be averaged over the period of Input Filter Time Constant. e.g. For an Input Filter Time of 0.5 second, the controller will be displaying the average of 8 input samples. In effect, this process filters out input signal noise by continuously averaging data over the selected time period, and updates the display and PID control algorithm with this filtered data.

The Remote interface uses the SDUR and QDUR? commands to set the Input Filter Time.

Since the Input Filter Time affects the PID control loop, correct selection of this value is necessary to ensure optimum PID control. Specifically:

- Selection of a short Input Filter Time may result in noisy control. This is especially true in systems that use aggressive Derivative terms since the derivative is most affected by both signal noise and input sample rate. The result may be reduced control accuracy near the set point and will be most obvious in systems where there are high noise levels (such as a Cryocooler).

- Selection of a long Input Filter Time will slow the responsiveness of the controller and may result in low level oscillations around the set point. This effect is identical to the selection of an Integrator time that is too long for the system being controlled.

For optimum PID control, the best value for the Input Filter Time is about one tenth of the Integrator time. This will provide the maximum noise rejection while still ensuring responsiveness and control stability. Smaller values may be used with relatively quiet systems, or systems where the Derivative term is not used. Larger values of Input Filter Time are not recommended.

5.3.5. Datalog

Refer to Chapter 8 for a discussion of the Datalog feature.

5.3.6. Sensor Configuration Menu

Choosing SENSORS from the INSTRUMENT SETUP SELECTION menu calls up the SENSOR CONFIGURATION menu used to specify the sensors connected to the inputs.

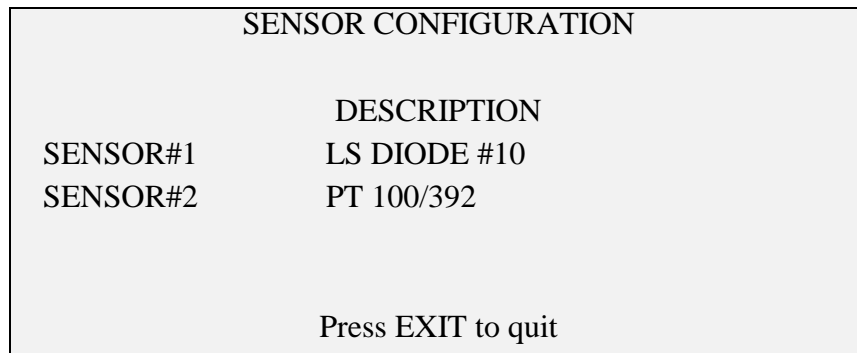

SENSOR CONFIGURATION	
	DESCRIPTION
SENSOR#1	LS DIODE #10
SENSOR#2	PT 100/392
Press EXIT to quit	

Figure 13 Sensor Configuration Screen

Use the cursor keys to move to the desired SENSOR# which refers to the SENSOR (INPUT) # labeled on the rear panel. Select the sensor type connected to this input using the INC (increment) and DEC (decrement) keys. The types of sensors presented may vary from instrument to instrument depending on configuration.

The Model LTC-21 will present the following choices for sensors in the Sensors Menu :

SENSOR TYPE	DESCRIPTION
LS DIODE #10	LakeShore™ Si Diode, Std. Curve #10
CryoCal D3	CryoCal™ Si Diode, Std. Curve D3
SI-410NN	Scientific Inst™ Si Diode
LS TG-120	LakeShore™ GaAlAs Diode, Std. Curve
PT 100/385	100Ω Platinum, European Std. (385Ω at 100°C) dc
PT 1000/385	1000Ω Platinum, European Std. (385Ω at 100°C) dc
PT 100/392	100Ω Platinum, American Std. (392Ω at 100°C) dc
PT 1000/392	1000Ω Platinum, American Std. (392Ω at 100°C) dc
CAL Resistors	For Calibration Purposes Use
USER TABLES HERE	Any user specified sensor

Table 4 LTC-21 Supported Sensors

When you select a new sensor, the LTC-21 will always leave the Control mode to prevent dangerous operating conditions. After selecting the desired sensor, press EXIT, MONITOR, or CONTROL to enter the sensor and exit the display.

5.3.7. Output Configuration Menu

Introduction to Configuring the Outputs

Choosing OUTPUTS from the INSTRUMENT SETUP SELECTION menu displays the OUTPUT CONFIGURATION menu used to assign and configure the HEATER and ANALOG outputs.

OUTPUT CONFIGURATION			
OUTPUT	SENSOR	MODE	MAX PWR
HEATER	#1	PID	5W
ANALOG	NONE	Monitor	Ramp
HEATER P= 150 I= 25 D= 6 P0= 0.0			
ANALOG GAIN= 1.00 OFFSET= 375.000K			

Figure 14 Output Configuration Screen

As usual, use the cursor keys to select the menu field you want to change and the INC and DEC keys to scroll through the choices for that field. The options available are summarized below:

MENU FIELD	CHOICES	PURPOSE
SENSOR	#1	Assigns the selected OUTPUT to SENSOR #1
	#2	Assigns the selected OUTPUT to SENSOR #2
	NONE	Disables the selected OUTPUT
MODE	AUTO P	AutoTuned; Proportional gain only
	AUTO PI	AutoTuned; Proportional and integral gain
	AUTO PID	AutoTuned; Full PID settings
	PID	Manually selected PID coefficients
	Table	PID coefficients selected from stored data
	Default	Factory default PID coefficients
	Monitor	Analog output used for temperature monitor
MAX PWR	OFF	Turns off the Heater
	0.05 W	Sets Maximum Output Power = 0.05 Watt
	0.5 W	Sets Maximum Output Power = 0.5 Watt
	5 W	Sets Maximum Output Power = 5 Watt
	50 W	Sets Maximum Output Power = 50 Watt

Table 5 Output Configuration Options

SENSOR Menu Field

This field assigns the outputs to a particular SENSOR# (input). The possible choices are: #1, #2, and NONE. Either output may be assigned to either sensor. Note that both outputs may be assigned to the same input. This may be used, for example, to regulate temperature using the HEATER output while monitoring small fluctuations using the ANALOG output. It is not possible (or reasonable) to assign both inputs to the same output.

MODE Menu Field

This field determines the method used to calculate the output power/current. There are five basic methods (MODEs) used; Auto PID, PID, Table, Default and Monitor. The MODE assigned to the heater is always displayed in the upper left hand corner of the Main Operating Display while the instrument is in CONTROL MODE.

PID Mode - The PID mode provides direct operator control of all PID coefficients. Correct selection of these terms is often difficult for cryogenic systems and may require substantial trial-and-error adjustment by the operator. Chapter 6 provides useful information which may help in selecting these values.

If the PID mode is selected, the screen will display the currently used values for P, I, D, and PØ.

OUTPUT PARAMETERS	
HEATER	ANALOG
P= 150	P= 50
I= 25Sec.	I= 10Sec.
D= 6Sec.	D= 0Sec.
P0= 0.00%	P0= 0.00%
Pwr Limit = 35%	Gain= 1.00
	Offset= 325.00

Figure 15 PID Mode Screen

To change these values, move the cursor to the desired field, enter the new value from the numeric keypad, and press ENTER. Exit from this menu using the EXIT key or return directly to the CONTROL mode using the CONTROL key. Note that you can change any of the PID coefficients without interrupting temperature regulation. Of course, if the new PID coefficients entered are not appropriate, temperature regulation may quickly deteriorate.

The P term is an arbitrary gain factor which can be chosen to have any value between 0.1 and 1000. Typical systems will operate with a gain of 10. If the gain is too high, the system will oscillate. If it is too low, it will be slow to respond.

The I term is given in seconds; its reciprocal is the angular frequency at which the integral term has gain equal to the P term. The range of allowed values is 0.1 to 10,000 seconds. The LTC-21 also recognizes $I = 0$ as a special case which turns the integrator term off completely.

The purpose of the I term is to provide extremely high gain near dc. This allows the temperature controller to regulate at the set point with negligible input error signal. Note that to minimize the effect of the integrator, the I term should be set to a large value, or 0 to completely turn it off. A typical cryogenic system will work with $I = 20$.

The D term is also given in seconds and its reciprocal is the angular frequency at which the D gain is equal to the P term. The range of allowed values is from 0 to 1000 seconds. Most systems work best with $D = I/4$. To minimize the effect of the D term, you should select a small value.

The PØ term provides a fixed output power independent of sensor value. It is given as a percent of full scale power with

$$0 < PØ < 100\%$$

and should usually be set to zero. It is most commonly used by itself (i.e. with P = I = D = 0) in order to fix the output power at a selected level.

☞ **Pwr Limit** - this is a safety setting for the 50W power range only. The default setting from the factory 35%. This is equivalent to 10W for the 50W Max Power range. If user desires to have more than 10W for the 50W range, simply increase the PØ term. If the PØ term is set to < 100% , and the heater is outputting at this limit, the heater output percentage sign will blink to signal that it has reached the preset limit.

Auto PID Modes- The Auto PID modes are used if you want the LTC-21 to automatically select PID coefficients. Three such modes are available; Auto PID, Auto PI, and Auto P:

Selection	Function
Auto PID	selects a complete set of proportional (P), integral (I), and derivative (D) coefficients.
Auto PI	sets the derivative term to zero.
Auto P	uses only proportional gain.

Table 6 PID Modes

The use of these modes is described in detail in Chapter 7.

TABLE mode - The LTC-21 provides five PID tables, each has 10 PID entries. When the Table mode is selected, the LTC-21 will use the current temperature setting and obtain the interpolated PID from the selected table for the specified temperature set points.

The Table mode allows the operator to select the PID coefficients from ten sets of values stored in each of the PID Tables. This eliminates the need to remember or reenter coefficient sets that have been stored. This is particularly convenient for use with systems that require very different coefficients at different temperatures. Once good coefficients have been determined for each temperature range, these can be stored in the table. The values can then be easily recalled from the table when returning to this temperature range.

If the Table mode is selected, the screen will change to display the table coefficients currently in use.

PID Table 4					
Set Pt	P	I	D	P0	Htr Rg
350.000K	50	20	5	0.00	50W
200.000K	70	25	7	0.00	5W
100.000K	100	15	9	0.00	5W
° 20.000K	120	15	6	0.00	0.5W
11.000K	60	10	3	0.00	0.05W

Press EXIT to return

Figure 16 Table Mode Screen

Example:

If the current experiment temperature is 150K, the PID setting will be 80-20-8-0.00. (For 150K, the interpolation process takes the PID & P0s from 200K and 100K entries, and yield the interpolated 80-20-8-0.00.) The heater range will be the 5W range. This will change the MAX PWR setting in the output screen if TABLE mode is selected.

To select a new Table entry for the Heater output, move the cursor to the Index field (the number after the PID Table heading) and use the numeric keypad to enter the new Index #. Press ENTER and then EXIT the menu in the usual way.

CAUTION:

The last Index selected before exiting the PID Table screen will be the PID Table selected. Be sure to enter the proper index upon exiting the table.

To change the entries in the Table, move the cursor to the desired field and enter the desired value from the numeric keypad. Press ENTER and then EXIT the menu in the usual way.

Default - If the Default mode is selected, the LTC-21 displays and uses the following factory default values for PID coefficients:

$$\begin{aligned} P &= 100 \\ I &= 10 \\ D &= 0 \\ P0 &= 0.00 \% \end{aligned}$$

Most systems can be regulated using these values, but the response will be far from optimum. The values were chosen to err on the side of stability rather than speed.

Monitor - The Monitor mode is only applicable to the ANALOG Output. The LTC-21 allows you to use the ANALOG output either as a low-power heater output or as a temperature monitor port. If Monitor is selected, OUTPUT PARAMETERS of Analog Gain and Offset are assigned to this output, rather than PID coefficients. Gain determines the change in output voltage for a given temperature change. Offset, given in sensor units, is used to Adjust the zero output point. For example, if a calibrated sensor is installed and the display units are selected to be Kelvin, the Analog Output voltage will be given by:

$$V = (\text{OFFSET} - \text{Temperature in Kelvin}) * \text{GAIN}$$

This feature is commonly used to monitor small changes in temperature on a chart recorder.

Example for Use with a Chart Recorder

For an application with temperature for sensor 1 is in the 230K to 240K range:

- In the Output configuration page, set both Heater and Analog Port to Sensor 1.
- Set Analog Port Mode to Monitor.
- By pressing Enter at Monitor, it shows the Output Parameters screen.
- Select Offset to 235K, and Gain to 1.00.
- The Chart Recorder connected to the Analog port will show its chart reading

$$\text{for 230K as } +5V = (235K - 230K) * 1.00$$

$$\text{for 235K as } 0V = (235K - 235K) * 1.00 \text{ and}$$

$$\text{for 240K as } -5V = (235K - 240K) * 1.00$$

- The Gain of 1.00 can be changed to 0.5 to get half of the scale.

If anything other than "Monitor" is chosen for the Analog Output, PID coefficients will be assigned to it in the same way that they are assigned to the Heater output. The Analog output can then be used as a low-power temperature regulator with a maximum output capability of 100 mW. AUTOTUNE is not available on the Analog output.

MAX PWR Menu Field

The MAX PWR field only applies to the Heater output and is used to set its maximum output power capability. Choices are OFF, 0.05 Watt, 0.5 Watt, 5 Watt, and 50 Watt. All of these settings assume that a 50Ω heater is connected to the output. The LTC-21 will work with other heater resistances, but the output power will be incorrectly displayed. Since the LTC-21 is configured as a current source, the actual heater power can be calculated from the following equation:

$$\text{Actual Heater Power} = (\text{Indicated Power}) * (R / 50)$$

This equation is valid for conditions which result in output power less than 50 Watt and output voltage less than 50 Volt.

For the 50 Watt output, there is a built-in power limit protection in the output configuration's PID mode setting. Please Refer to PID mode on PWR Limit setting.

Ramp Menu Field

This menu field is used to setup the Temperature Ramp parameters and appears as shown below. The currently selected field will appear as flashing text.

Ramp Configuration			
Set Point:	290.000KK	
Target Temperature:	400.000K		
Degrees Per Minute:	50.000K		
Channel Number:	#1		
Ramp Armed:	OFF	Idle	
Heater:	0% of 5W		

Figure 17 Ramp Configuration Menu

In order to change the setup parameters, press the cursor keys until the desired selection is shown in flashing text. For the Set Point, Target Temperature and the Degrees Per Minute fields, enter a new value via the numeric keypad and press the ENTER button. For the Channel Number and Ramp Armed fields, simply press the INC/DEC keys.

TheK field displays the current temperature.

To execute Ramping, the Ramp Armed field must be set to ON and the Mode set to PID or Table (not Autotune). Enter the Control Mode to begin the Temperature Ramp. Idle will be replaced by Ramping in the Ramp Configuration Menu. Reaching the Target Temperature or entering the Monitor Mode will terminate Ramping.

5.4.8. Misc Menu

5.3.7.1. Introduction to the MISC MENU

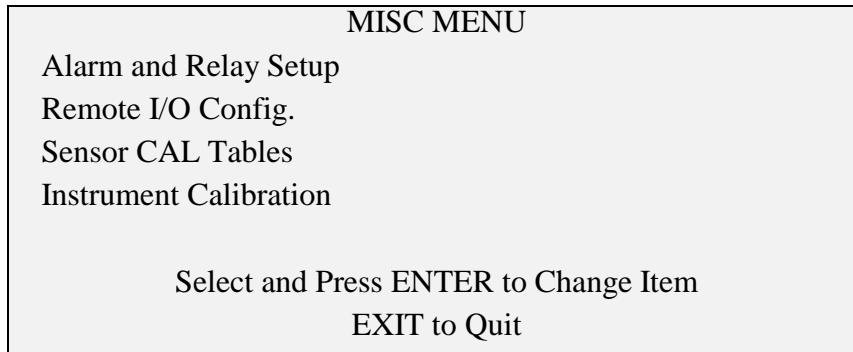

Figure 18 Misc Menu Screen

The MISC MENU is used for the following functions:

SELECTION	FUNCTION
Alarm & Relay Set Points	Configures the Alarms & Relays
Remote I/O Configuration	Configure IEEE-488 and RS-232 ports
Sensor CAL Tables	Enter/Modify Sensor Calibration Tables
Instrument Calibration	Recalibrates the LTC-21

Table 7 Misc Menu Selections

5.3.8. Alarm & Relay Set Points

To change the configuration of the Alarms or Relays, select the Alarm and Relay Set Point menu item from the MISC MENU; this will display the Alarm and Relay Configuration menu.

Alarm and Relay Configuration			
	Status	High Lim	Low Lim
Alarm 1	Armed	295.000K	235.000K
Alarm 2	Disarmed	450.000C	-100.000C
Relay 1	Armed	290.000K	200.000K
Relay 2	Disarmed	-271.000C	100.000C

Figure 19 Alarm & Relay Setup Screen

Use the cursor keys in the usual way to select the item you want to change.

Alarm 1 and Relay 1 (displayed in the first column of the Alarm and Relay Configuration Menu) are always assigned to Sensor #1; Alarm 2 and Relay 2 are always assigned to Sensor #2. The Status of the alarms and relays is displayed in the second column. Each alarm and relay may be separately armed (enabled) or disarmed (disabled).

The High Lim and Low Lim columns of this display are used to change the set points. Move the cursor to the limit you want to change, enter the new value with the numeric keypad, and press ENTER. If the temperature exceeds High Lim or drops below Low Lim, the internal audible alarm will sound continuously. Likewise, the relays will change state (i.e. the normally open contacts will close) if the temperature goes outside the selected limits. The relays will remain in this state until the temperature returns inside the limits. Each relay contact is rated at 0.5A, 30V_{rms} or 60V_{DC} with a non-inductive load. Pin assignments for the relay connector are given below.

Relay	Normally Closed	Common	Normally Open
1	pin 8	pin 7	pin 6
2	pin 5	pin 4	pin 3

Table 8 Relay Connector Pin Assignment

5.3.9. Remote I/O Config.

Select Remote I/O Config. from the MISC MENU to change the remote I/O setups, e.g. IEEE-488 bus address. Detail on remote I/O commands are described in Appendix A & B.

Remote Input/Output Configuration	
Remote I/O Selection:	IEEE-488
IEEE-488 Bus Address:	15
RS232 - Baud Rate:	9600
RS232 - Parity:	None
RS232 - Bits Per Word:	8
Press EXIT to return	

Figure 20 Remote Input/Output Configuration Screen

The system is configured with IEEE-488 as default settings. User can change to RS232. Only one of the two can be activated at one time. Enter any desired IEEE-488 bus address between 1 and 31 (inclusive) using the numeric keypad. The LTC-21 supports RS-232 baud rates between 300 and 19,200. These are selected using the INC and DEC keys in the usual way. RS232 is set to “Parity None”, and Bits per word as “8” and cannot be changed. The display is for informational use only. Once an selection is made, press EXIT to activate the change.

5.3.10. Sensor CAL Tables

All the information required to utilize any specific sensor is stored in non-volatile memory in a Sensor CAL Table. Two types of Tables are used. One type has been loaded at the factory and can not be changed by the user. These tables store standard calibration curves for 8 different resistive and diode sensors. The other type of table is loaded by the user and can accommodate nearly any type of cryogenic sensor manufactured. Up to 16 user entered calibration tables may be entered.

Each Sensor CAL Table includes a mandatory header followed by an optional calibration table. The mandatory header specifies everything needed to bias the sensor and correctly read its value in fundamental sensor units (Ohms, Volts, or LogOhms). The optional calibration table is used to convert the fundamental units into temperature. Each calibration table accommodates up to 149 calibration points.

5.3.11. Entering a New Sensor Table

Entering a new sensor is a simple, straightforward process that can be done entirely from the front panel. It can also be done via either interface port as described in Appendix A.

Sensor Parameters	
Sensor Type:	R1.0M ac
Voltage Bias:	3 mv
Cal Table Units:	LogOhms
Multiplier:	-1.000
Description:	CGR 2.5-300K
Edit Cal Table	

Figure 21 Sensor Parameters Screen

"Sensor Type" selection

The “Sensor Type” field allows the user to select the bias technique and algorithm used to measure and calculate temperature. Use the INC (or DEC) key to select the Sensor type that most closely resembles the characteristics of the sensor you desire to use. Sensor type selections are: “Diode 2V”, “Diode 6V”, “R250 DC”, “R2500 DC”, “R1.0

AC”. Menu selections “Diode 2V”, “Diode 6V”, “R250 DC”, “R2500 DC” bias the sensors with constant dc current.

“R1.0M AC ” biases the sensors at a constant voltage which can be selected by the user. AC bias voltage choices are: 10mV, 3mV, 1mV, 320 μ V, 100 μ V, 32 μ V, and 10 μ V peak-to-peak. This allows the user to reduce the power across the sensor, increasing the range and utility of the LTC-21, especially for use at lower temperatures.

Please refer to the table below when choosing a sensor and an excitation voltage for your application.

Excitation Voltage	Accuracy	Resistance Range
1mV	0.1%	1 Ω to 1 M Ω
320 μ V	0.1%	1 Ω to 500 k Ω
	1%	500 k Ω to 1 M Ω
100 μ V	0.1%	1 Ω to 150 k Ω
	1%	150 k Ω to 1 M Ω
32 μ V	0.5%	1 Ω to 50 k Ω
	2%	50 k Ω to 500 k Ω
	10%	500 k Ω to 1 M Ω
10 μ V	0.5%	1 Ω to 15 k Ω
	2%	15 k Ω to 150 k Ω
	10%	150 k Ω to 1 M Ω

Table 9 Excitation/Accuracy/Resistance Range

The following table can serve as a guide when choosing “Sensor Type” menu selections for various sensors.

Sensor Type Desired	Sensor Type Menu Selection (Recommendations)
Any ac Biased Sensor	R1.0 M AC. Constant voltage excitation level choices: 10 mV, 1 mV, 3 mV, 320 μ V, 100 μ V, 32 μ V, and 10 μ V.
Si Diode	Usually 2V Diode, occasionally 6 V Diode. Check the diode manufacturer's specification for details.
GaAlAs Diode	6 V Diode
Platinum 100 Ω (@ Room Temp)	R250 DC
Platinum 1000 Ω (@ Room Temp)	R2500 DC
RhFe RTDs	R1.0 M AC R250 DC or R2500 DC depending on temperature range
Carbon Glass	R1.0 M AC R250 DC or R2500 DC depending on temperature range
Ruthenium Oxide	R1.0 M AC, if used at low temperatures 10 mV, 1 mV, 3 mV, 320 μ V, 100 μ V, 32 μ V, and 10 μ V. R2500 DC
Germanium Resistor, ThermOx™, Cernox™	R1.0 M AC if used at low temperatures 10 mV, 1 mV, 3 mV, 320 μ V, 100 μ V, 32 μ V, and 10 μ V. R250 DC or R2500 DC depending on temperature range

Table 10 Sensor Type Selection

"Cal Table Units" selection

Use the down-arrow key to select the "Cal Table Units" choice and then use the INC or DEC key to select "Volts", "Ohms", or "LogOhms".

Sensor Type	Cal Table Units
Diode	Volts
Platinum	Ohms
Carbon Glass or other resistive sensors with logarithmic temperature characteristics	Log Ohms

Table 11 Cal Table Units

"Edit Cal Table" selection

Refer to the "Optional Entry of Calibration Table" paragraph later in this section.

"Multiplier" selection

Use the down-arrow cursor key to select "Multiplier" and enter the desired value using the numeric keypad. The multiplier is used to scale the calibration table's Volts(or

Ohms) column by a constant factor, i.e. if the calibration table has an entry pair of 100K and 10Ω with a multiplier of 2.000, the LTC-21 would interpret the entry pair as 200 K and 20Ω. The multiplier is almost always set to 1.000. Enter a multiplier other than 1.0000 only under the following two conditions:

- Enter a minus sign in front of the multiplier if your sensor has a negative temperature coefficient (sensor reading decreases with increasing temperature) AND you do not enter a temperature calibration table. Diodes normally have negative temperature coefficients.
- Use a different value than 1.0000 so that you can scale an existing table. This is most commonly done with platinum sensors. For example, a standard calibration curve can be entered for a 213Ω platinum sensor (213Ω at 0 °C) by entering the calibration curve for a standard 100Ω sensor and a multiplier of 2.130.

"Description" selection

Use the down-arrow cursor key to select "Description" and enter any desired identifier from the numeric keypad. Alpha-numeric descriptions are allowed, but must be entered from a computer using either interface port (see Appendix A). The LTC-21 does not check to see if the selected identifier is unique. Existing tables are not overwritten, even if they have the same identifier. This can result in multiple tables having the same identifier.

Optional Entry Of Calibration Table

If you do not wish to enter a calibration table, Press SETUP, CONTROL, MONITOR, or EXIT to leave this display and save the sensor configuration.

If you wish to enter a calibration table, position the cursor key to the **"Edit Cal Table"** and push ENTER. You will be in the Calibration Table View /Edit Menu.

Calibration Table View/Edit Menu		
Description:	user	
Entry #	Kelvin	Volts
0	999.9902	0.0000V
1	0.0000	-1

Figure 22 Sensor Calibration Edit/View Screen

Use the cursor keys and numeric keypad to enter the calibration table. You must observe the following conventions:

- All sensor entries must be in the units shown at the top of the columns; All temperatures must be in Kelvin. You must convert your data to Kelvin and

the displayed sensor units before proceeding to enter the data in the calibration table.

- You may enter the table with sensor units in any order; Upon exiting, the system will sort the table into sensor units Ascending order.
- If you have chosen LogOhms sensor units, you must enter the log (base 10) of the resistance in ohms, i.e. 100 ohm is entered as 2.0000
- All values must be in the following ranges:
 - 0 to 800 Kelvin for temperature,
 - 1 Ω to 9.999 M Ω , for resistance,
 - 0 to 5.8 volt.
- The last point in the table must be -1 in the sensor units column. Note that the LTC-21 automatically enters this point for you. The temperature value entered next to -1 is the value that will be displayed if your sensor reading exceeds the calibration table limit (the value located above the -1 in the table). If your sensor reading exceeds the table at the other end, the display will show the temperature in Entry #0 in the table.
- Enter no more than 149 data pairs in the table
- Edit the table by overwriting any entry
- Delete the entry by entering -1 in the sensor unit column.

When you are done, press EXIT, SETUP, CONTROL, or MONITOR to terminate table entry and store the values.

5.3.12. Viewing and Editing a Sensor Table

The procedure for viewing any Sensor Table is the same whether it is a user entered table or standard table. However, it is not possible to edit a standard table. To View/Edit a Table:

1. Press SETUP, select "MISC." and press ENTER
2. Select "Sensor CAL Tables" and press ENTER

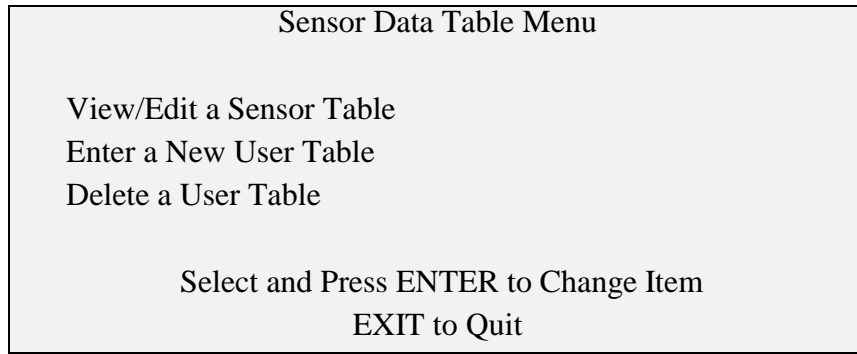

Figure 23 Sensor Cal Table Menu Screen

3. Select "View/Edit Sensor Table" and press ENTER
4. Use the up and down cursor keys to select the desired sensor table. Press ENTER.
5. Use the up and down cursor keys to scroll the sensor data. If this is a standard table you will only be able to view the data.

CAUTION:

If You Are Viewing A User Table, Be Careful Not To Accidentally Change Any Entries. You Should Read And Be Thoroughly Familiar With Section 5.4.12 Of This Manual "Entering A New Sensor Table", Before Changing Any Entries In The Sensor Table.

6. Edit any selected entry by overwriting it with a new value entered from the numeric keyboard. Delete each entry by entering -1 in the sensor unit column.
7. Enter new values by adding the new entry at the end of the table. Upon exiting the table, the table will be sorted automatically.
8. When you are done, press EXIT, SETUP, CONTROL, or MONITOR to exit and save this table.

5.3.13. Deleting a User Table

You may delete an entire user-entered Sensor Data Table, but it is not possible to delete a factory-entered standard table. To delete a user-entered Sensor Data Table:

1. Press SETUP, select "MISC." and press ENTER

2. 2. Select "Sensor CAL Tables" and press ENTER
3. Select "Delete a User Table" and press ENTER
4. Use the cursor keys to scroll through the listing of tables and select the table you wish to delete.
5. Press CLEAR twice to delete the table. After you press CLEAR the first time, text on the display will flash "press CLEAR to delete". You must press CLEAR a second time to delete the selected table.

5.3.14. The Instrument Calibration Menu

The instrument calibration menu is used to view or change sensor channel calibration information. This includes Analog-to-Digital converter offset and gain information and constant-current-source data.

This menu is entered via the MISC menu.

To check or re-calibrate your instrument, refer to the "Temperature Controller Calibration Guide" for your model.

Note that the *****WARNING***** field has special significance. When the cursor is moved to this field, it will begin to flash. Now, if the ENTER button is pressed, the LTC-21 will move to the "Input / Output Tests Menu".

5.3.15. Input / Output Tests Menu

The Input / Output Tests Menu allows the user to exercise various functions of the instrument as part of a diagnostic or calibration procedure.

This menu is entered via the Instrument Calibration Menu as described in the previous section.

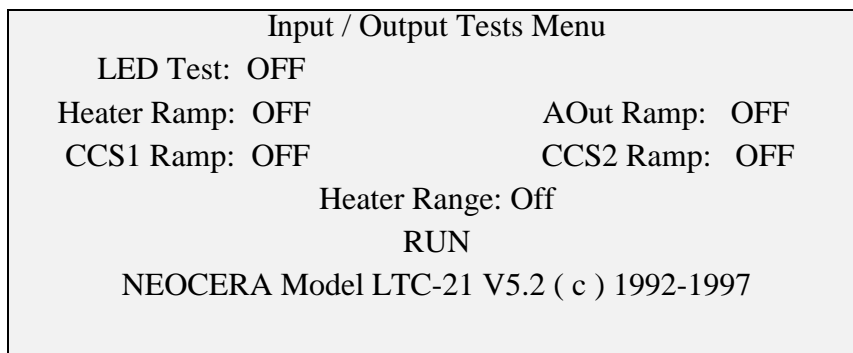

Figure 24 Input/Output Tests Menu Table

Tests of the front panel LEDs, the Heater output and the Analog output may be performed using this menu. Details of these testing procedures are given in Section 10.3, Self Tests.

The last line on the display shows the following information:

- The Model Number.
- The Software Revision number (V5.2 shown).

Chapter 6

PID Theory Tuning and Ramping Tips

6. PID Theory And Tuning Tips

6.1. The LTC-21 PID Mode

The PID mode provides direct operator control of all PID coefficients. Correct selection of these terms is often difficult for cryogenic systems and may require substantial trial-and-error adjustment by the operator. If the PID mode is selected, the screen will display the currently used values for P, I, D, and P0. The LTC-21 allows you to change any of the PID coefficients without interrupting temperature regulation.

Before trying to optimize your choice of PID coefficients, it may be necessary to configure the Analog output as a Monitor port and connect a chart recorder to it, or perform some type of data collection using a computer. It is nearly impossible to get good results by simply observing the front panel display.

6.2. Selecting Coefficients

After you are prepared to monitor the temperature on a chart recorder or computer, select your best estimate for the PID coefficients and watch the output as the system comes to equilibrium at the setpoint. If you are fortunate, the output will be stable at the desired temperature. If not, observe the period and amplitude of any oscillations that occur.

Then change the setpoint and observe the temperature as it tries to reach the new setpoint. It should quickly come to the new setpoint with no more than a few overshoots on either side. If not, observe the amplitude of each overshoot and the rate that they decay (if at all). All the information you need to set the PID coefficients can be obtained from simple measurements exactly like these.

The following sections give hints as to how to use this data to select PID coefficients.

The P term is an arbitrary gain factor which can be chosen to have any value between 0.1 and 1000. Typical systems will operate with a gain of 10. If the gain you used was too high, the system will oscillate. If it is too low, it will be slow to respond.

Since incorrect values of the I and D terms can cause oscillations that appear similar to too-high gain, it is best to first select values for the I and D terms (see below) and then adjust the gain. To select your first guess for the P term and to gather information needed to select the I term, you should turn up the P gain slowly until the system begins to oscillate. To do this, use the PID mode with I and D both set to zero. Then slowly select increasing values of P until the system oscillates. Observe the oscillation period and then turn the gain back down until the oscillations are very small or disappear completely.

The I term is given in seconds; its reciprocal is the angular frequency at which the integral term has gain equal to the P term. The range of allowed values in the LTC-21 is 0.1 to

10,000 seconds. The LTC-21 also recognizes I=0 as a special case which turns the integrator term off completely.

The purpose of the I term is to provide extremely high gain near dc. This allows the temperature controller to regulate at the set point with negligible input error signal. Note that to minimize the effect of the integrator, the I term should be set to a large value, or 0 to completely turn it off. A typical cryogenic system will work with I = 20.

You can get a good estimate of the best value for the I term by observing the natural period of oscillation that occurs when the gain is too high. Simply use the oscillation period TN observed with the P gain set too high (see above) and then select

$$I = 0.5 * TN$$

The D term is entered in seconds and its reciprocal is the angular frequency at which the D gain is equal to the P term. The range of allowed values in the LTC-21 is from 0 to 1000 seconds. Most systems work best with $D = I/4$. To minimize the effect of the D term, you should select a small value. Never select values where $D > I/2$. For your first guess, select $D = I/4$

The P0 term provides a fixed output power independent of sensor value. It is given as a percent of full scale power with $0 < P0 < 100\%$ and should usually be set to zero. It is most commonly used by itself (i.e. with $P = I = D = 0$) in order to fix the output power at a selected level. Unless you have a specific reason not to, select $P0 = 0$.

6.3. Fine Tuning the Coefficients

The techniques described above should give you a reasonable estimate of the PID coefficients needed. You can improve on these by making small changes to each coefficient separately and observing the systems response to a change in setpoint. You need to be careful when interpreting these results since changing the P term will also change the effect of the I and D terms. Vary all three terms individually and systematically by a small amount in both directions. You should be very suspect of your combination of choices if you have either:

- a. an I term where $2 * TN < I$ or $TN > 8 * I$
- b. a D term where $D > 0.4 * I$

6.4. Ramping

The power generated by the LTC-21's control loop can be expressed as:

$$\text{Power} = k * \left[\mathbf{P} * (T - T_{\text{set}}) + \frac{\mathbf{C}}{\mathbf{I}} \int p(t) dt - \mathbf{D} \frac{dT}{dt} \right]$$

where k is a constant (having units of W/K)

P is the proportional or gain coefficient (dimensionless),

T and T_{set} are the current and target temperatures (in K)

$p(t)$ is the power output of the controller from over the last I seconds

C is a constant (units of watt⁻¹)

I is the integral coefficient (units of seconds)

D is the differential coefficient (units of seconds).

The ramp rate is defined by $R = \Delta T / \Delta t$, where $\Delta T = T_{\text{initial}} - T_{\text{set}}$. The integration time (I) in seconds corresponds to the system response time. Because of this, there will be an inherent thermal lag on the order of I . Obviously, it is unrealistic to set a ramp rate faster than the system can respond, e.g., setting $R = 1$ million K/min. For a ramp of rate R , you can expect a temperature deviation (both at the start and completion of the ramp) on the order of $\delta T = I R$. A good rule of thumb is to have $|\Delta T / I R| \gg 1$.

If you are ramping over a wide temperature range, it may be worthwhile to use the TABLE rather than PID mode in the output configuration menu. Obviously, to get the best ramping performance, it is best to predetermine the optimum PID coefficients using the AUTOTUNE mode.

Chapter 7

Using Autotune

7. Using Autotune

7.1. Introduction

The AUTOTUNE mode of the LTC-21 will select optimized PID coefficients to regulate the temperature of most cryogenic systems. It is a highly effective technique that usually obtains excellent results, even with difficult-to-regulate systems. It is very unusual for the operator to be able to find better coefficients than are selected automatically. Many systems can be regulated using the AUTOTUNE function that are nearly impossible to adjust manually, even after hours of trial-and-error searching.

The autotuning algorithm used is a complex, multi-step process that checks for a wide variety of conditions which could cause problems in determining optimized PID coefficients. The fundamental principles, however, are quite simple. It begins with the system in a steady state condition (constant power and temperature) and applies a sequence of controlled changes in power. Optimized coefficients are calculated based on the system's response to these changes.

Although the AUTOTUNE algorithm is extremely robust, there are some systems for which it will work poorly or not at all. These are almost always systems that have a large, temperature-dependent time delay before the thermometer responds to a change in heater power.

7.2. AUTOTUNE Basics

In order to begin using AUTOTUNE, you must:

1. **STABILIZE THE SYSTEM** -- The AUTOTUNE function must begin with the system in a steady-state condition. The output power and temperature must both be steady. You can achieve this any way you want. Usually, the DEFAULT PID coefficients will stabilize the system if you wait long enough. If this doesn't work, you can set a constant output power (use PID with $P = I = D = 0$ and $10\% < P0 < 90\%$).

2. **SELECT AUTOTUNE** -- After the system has stabilized, simply select AUTOTUNE by selecting one of the three Autotune choices(AUTO_PID, AUTO PI, or AUTO P) from the output configuration page. This puts the system in the

OUTPUT CONFIGURATION			
OUTPUT	SENSOR	MODE	MAX PWR
HEATER	#1	AUTOPID	5W
ANALOG	NONE	Monitor	Ramp
HEATER	P= 150	I= 25	D= 6 P0= 0.0
ANALOG	GAIN= 1.00	OFFSET=	375.000K

selected AUTOTUNE mode and displays this choice in the upper left-hand corner of the main display page. In most cases, you will use the AUTO PID mode. The LTC-21 will stay in this mode until another mode is selected.

3. **SELECT TUNING PARAMETERS** -- After the Autotune selection, the LTC-21 also provides two tuning parameters. The first one is called system response time. This is a thermal property of the system. The sections are NORMAL, SLOW and FAST. The default is set to NORMAL. If the system temperature response is extremely sensitive, you may select FAST. On the other hand, if the system response to the heater is very slow, you should select SLOW. The second parameter is the Retune Interval. It is set to 10% initially. This parameter defines the interval, measured by the setpoint deviation from the last Autotune temperature in Kelvin, from which the system should update and do another Autotune. For example, if the Autotune is done at 100K, and a new setpoint of 105K is entered, since it is less than 10% deviation from 100K, the LTC-21 will not retune. It will use the last set of PIDs from the autotuning process. If a new setpoint of 112K is entered, the system will, however, go into Autotune to obtain a new set of PIDs. The range for this parameter is from 0.1% to 50%. Any value entered less than 0.1% will be taken as 0%, i.e. always do another Autotune when the user entered a new setpoint. This is handy when the user is experimenting with the Autotune process.

4. **SELECT A NEW TEMPERATURE** -- Enter a new setpoint in the usual way (press ENTER while in the CONTROL mode). By selecting a new temperature, it will put the instrument into the Autotune motion. The upper left corner of the display will blink TUNING to indicate the LTC-21 is in the process of determining PID coefficients.

TUNING	Sensor #1	Sensor #2
	348.782K	-263.854C
Set		
Point	350.000K	
	Heater 23% of 5W push ENTER to change SET POINT	

The LTC-21 will begin the Autotune algorithm and then proceed to regulate the system at the new set point using optimized coefficients. It will continue to use these coefficients for small changes in the set point (less than the Retune Interval percentage from the temperature, in Kelvin, where it originally selected these coefficients). If a larger change in setpoint is made, the system will go through the Autotune algorithm again and select new coefficients.

Each Autotuning process will take a different amount of time depending on the thermal characteristic of each system. The averaged time for each Autotune process is as below:

System Response Time Selected	Fast	Normal	Slow
Averaged Time for each AUTOTUNE	1.5 minutes	5 minutes	12 minutes
Time-out Exit	7 minutes	20 minutes	70 minutes

Table 12 Autotune Process Time

If an Autotune is unsuccessful, it will time-out and return to CONTROL mode with its PID values restored.

7.3. Advanced Usage of AUTOTUNE

Correcting Common Problems

In most cases, your system temperature will regulate tighter and faster using AUTOTUNE than with manually selected coefficients. If it doesn't regulate well, the following are the most likely causes of problems:

1. The System Was Not At Equilibrium With Constant Temperature And Power Before Starting Autotune.

You can often get reasonably good coefficients even if the system is not stable when you start, but failure to begin with the system stable is the most common cause of AUTOTUNE failure. With difficult-to-tune systems, it is sometimes helpful to try autotuning even if the system is not stable. Even if the results are less than perfect, you can use these coefficients to achieve a stable starting point for AUTOTUNE. Simply exit AUTOTUNE (go to MANUAL PID from the SETUP OUTPUTS menu) and reenter AUTOTUNE again.

2. The System Is Very Slow To Respond To Heat Changes.

Even if AUTOTUNE is capable of working in principle, it may time-out before it determines coefficients. If you are working in the NORMAL AUTOTUNE mode, simply select the SLOW AUTOTUNE mode and try again. This should work for any system with a characteristic response time less than a few minutes. For extremely slow systems, AUTOTUNE may still time-out. The best remedy is to redesign your system to reduce its thermal time constant. If this is not practical, you should manually select coefficients (see Section 7.1) as follows:

$$\begin{aligned} T_i &> 100 \text{ sec} \\ T_d &= 0 \\ K &= 1 \end{aligned}$$

If the system oscillates, turn down the gain by a factor of ten. If it seems sluggish and doesn't oscillate, increase the gain until the system just begins to oscillate. After you get reasonably good results, change T_d so that $T_d = 0.25 * T_i$. This procedure can be frustrating since the system is so slow that it takes many minutes to observe the results of a change.

3. The System Has A Long Lag Time.

This type of system appears similar one with a long time constant, but it is different in the following way. A long lag system will have essentially no response to a change in heater power for some period of time. It may then begin to respond rather quickly. Such systems usually are the result of mass flow, e.g. warmed gas must flow from the heater to the thermometer before the thermometer can begin to respond. AUTOTUNE will usually yield coefficients for this type of system, but they may not be well optimized. These systems are generally very difficult to regulate using a PID system and the best advice is to try to redesign the system.

Chapter 8

Using Data Log

8. Using Data Log

8.1. Introduction

LTC-21 provides data log as a feature that is commonly used for data monitor function. For most applications, this can save the researcher or experimenter a great deal of time for data recording for a particular event. LTC-21 saves data in non-volatile memory, thus the user can turn off the power of the LTC-21, transported to a location and can upload the information to a computer or remote device.

8.2. DATA LOG Function

From the SETUP screen, the user can choose DISPLAY to get to the DISPLAY CONFIGURATION screen. There are two screen dedicated for data log, they are the SETUP DATALOG and DISPLAY DATALOG menus.

8.2.1. DATA LOG SETUP

Choosing SETUP DATALOG from the DISPLAY CONFIGURATION menu calls up the Data Log Configuration menu.

Data Log Configuration	
Sample Interval:	10 seconds
Sensor Channel:	#1
Total Samples/Channel:	500
Acquisition Mode:	One Shot
Current Time:	00:00:00
Press ENTER to start Data Log	

Figure 25 Datalog Configuration Screen

Enter will start a new session of data log.

CAUTION:

The ENTER key in DATALOG configuration will start a new session of DATALOG. It will clear the buffer, and start to log data. Be sure to save or analyze the previously logged data before pressing ENTER.

CAUTION:

The **ENTER** key in **DATALOG** configuration will start a new session of **DATALOG**. It will clear the buffer, and start to log data. Be sure to save or analyze the previously logged data before pressing **ENTER**.

MENU FIELD	CHOICES	PURPOSE
Sample Interval	1 seconds	Collect data every second
	10 seconds	Collect data every 10 seconds
	1 minute	Collect data every minute
	5 minutes	Collect data every 5 minutes
	10 minutes	Collect data every 10 minutes
Sensor Channel	Both	Collect data from both sensors
	#1	Collect Sensor #1 data and heater power output
	#2	Collect Sensor #2 data and heater power output
Total Samples/Channel	4 to 500	Buffer Size
Acquisition Mode	One Shot	Acquire One buffer full of data
	Cyclical	Continuous data collection
Current Time	Hr:Min:Sec	Set current time of date

Table 13 Datalog Configuration Selections

Sample Interval field

This field sets the sampling interval for each data log. Every 1/10/60/300/600 seconds, the system will save the data into the data memory.

Sensor Channel field

User may choose to select sensor #1, #2 or Both sensors. For #1 or #2, the data collected will include current time of date, data collected with the Display Units assigned, and the Heater Power in percentage form.

Total Samples/Channel field

The internal buffer set aside is 500 data samples. User may choose to set it to any value that is between 4 to 500. Sometimes, a small buffer will not confuse the issue.

Acquisition Mode field

The two choices here are Oneshot and Cyclical. Oneshot provides the data logging of the said total samples ONE time. Cyclical provides continuous data collecting in a ring buffer. You may setup the **DATALOG** to be collecting 100 data samples, or you may set it up to

collect the last 100 data samples. If the experiment need to run overnight, Oneshot will save one buffer full of data. Cyclical will save the last one buffer full of data. The choice is yours.

Current Time field

The system does not have a separate clock. Each time after the system is powered up, user needs to reset this field. If this field is not set, it will just use 00:00:00 as the starting time. In entering Hour:Minute:Second, you may use the two side arrow key to move from one field. The Enter key will have the side effect of starting a NEW data log.

8.3. Display Datalog

Choosing DISPLAY DATALOG from the DISPLAY CONFIGURATION menu calls up the Data Log Display menu.

Data Logging Display 09:06:00		
200 Samples, 10 sec interval, One Shot		
Time	Sensor #1	Heater Power
°09:05:30	27.987K	35%
09:05:40	27.995K	35%
09:05:50	27.987K	35%
09:06:00	27.995K	34%
UP / DOWN cursor to scroll entries		

Figure 26 Datalog Display Screen

For One Shot data log, it collects the number of samples as specified and stops. The data presented is in the logged data order. It will enter the Data Logging Display to show the last four samples of data. Users may use the UP/DOWN cursor to see other data. It will not pass the last logged data.

For Cyclical data log, it continuously collects data into the buffer. The data is presented in the same logged data order, with the exception of also allowing the user to traverse through the who data buffer. Each time when entering into the Data Log Display menu, it will always position to see the latest logged data. Users may traverse forward and backward using the UP/DOWN cursor.

While in the Data Log Display menu, user may use the CLEAR key to abort any data logging session. The data in the buffer are not cleared.

The time of data field and new data log entries are not automatically updated. User should use the UP/DOWN cursor to see the update. This enables the user to copy down the data values.

Chapter 9

LTC-21 Functional Description

9. Model LTC-21 Functional Description

9.1. Block Diagram

A block diagram of the LTC-21 is shown below:

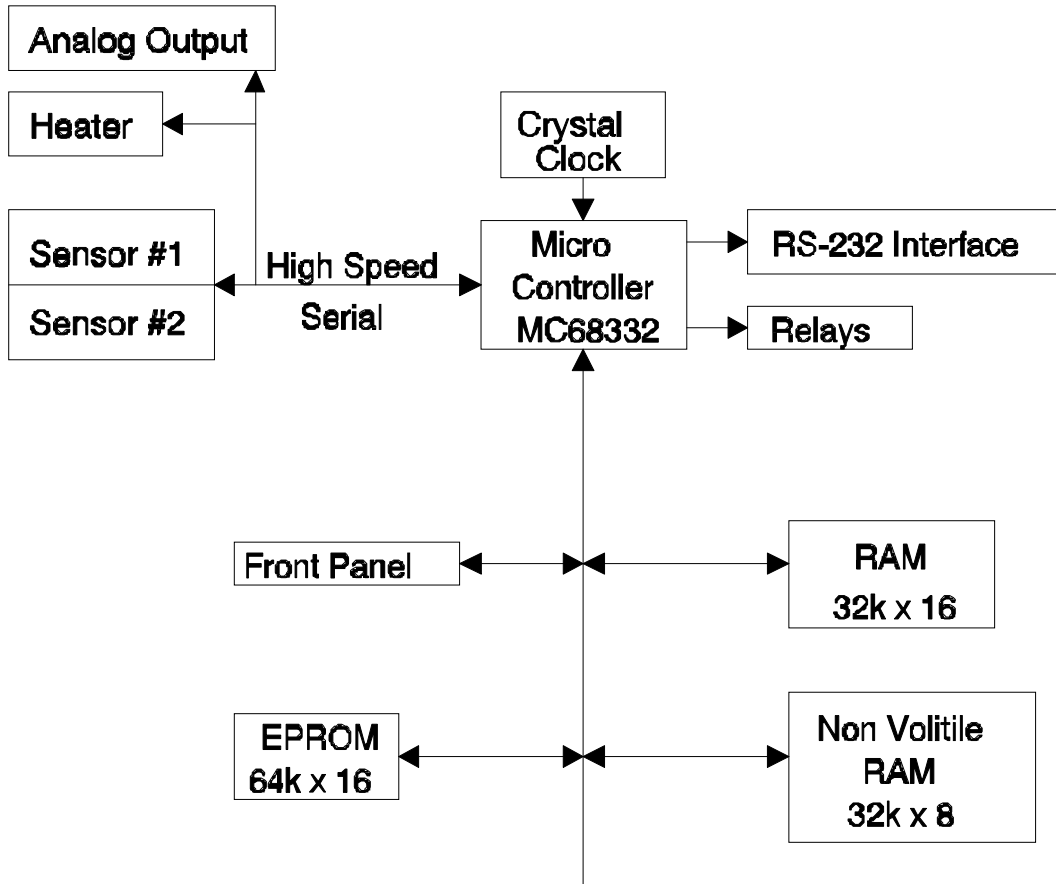

Figure 27 LTC-21 Functional Block Diagram

The entire instrument is under control of a very fast embedded microcomputer. Analog front-ends and outputs are kept to the simplified form possible. This allows easy re-configuration of the instrument by changing only software that is stored in EPROM. Further, the minimization of analog circuitry reduces noise and drift problems.

One primary feature of the MC68332 microprocessor is its high speed, bi-directional serial port. This port transfers data at One Megabit per second and is used as the primary interface to the Heater DACs, the Analog Output Channel DAC, and both DACs and ADCs on the

sensor channels. Using this scheme, optical coupling has been provided between all analog devices and the digital circuitry using only a minimum number of coupler devices.

The Micro Computer Block

The central processor unit is a Motorola MC68332 embedded micro controller chip. This processor has the following major features:

- 32 bit instruction execution.
- 17Mhz clock.
- Low power CMOS construction.
- Software compatible with the MC68020 family.
- Two serial I/O ports
- Built-in failure detection

The RAM Memory

The controller has 64K by 16 bits of Random Access Memory. Contents of this memory is lost when ac power is removed.

This RAM memory contains data such as the processor stack, heap etc.

The PROM Memory

The LTC-21 contains 128K x 8 bits of EPROM in the system. This contains:

- Microcomputer Programs.
- Factory supplied sensor calibration tables.

Software can be updated in the field by replacing EPROMs. Since virtually everything in the instrument is under computer control, significant changes to the controller may be made by simple EPROM changes.

Note that this memory is socketed and may be changed without affecting the basic calibration of the instrument.

The Non-volatile RAM Memory

The LTC-21 contains 32k x 8 bits of non-volatile RAM. This is battery backed memory that will retain data for a period of 10 years; even with ac power to the unit turned OFF.

This memory contains:

- All instrument calibration data.
- Setup information.
- User sensor and calibration tables.
- Datalog values.

If the contents of this memory is cleared, as described in Chapter 10, all of the above information is lost and factory supplied defaults are set.

Interface Ports

The LTC-21 has input/output ports for the IEEE-488 and RS-232 interfaces on the motherboard. The RS-232 port is part of the micro controller chip whereas the IEEE-488 interface is implemented in discrete circuitry using an industry standard controller chip set.

9.2.Operation.

During normal operation, the interrupt timer within the LTC-21's micro controller is set to a period of 62.5ms. Upon each interrupt, the following sequence occurs:

- The Analog-to-Digital converter ports from all sensor channels are read via the high speed serial port.
- Conversion to temperature is performed, based on the units selected for each channel, as required.
- If the instrument is in CONTROL mode, an enhanced PID algorithm is applied to the temperature data in order to generate both the Heater and Analog Output values.
- Control voltages are output to both output port Digital-to-Analog converters.

Note that the display averaging function averages temperature for display purposes only; It does not affect the sample rate of the loop itself.

Chapter 10

Adjustments and Calibration

10. Instrument Adjustments, Self Test and Calibration Procedures.

The following sections describe calibration procedures for the LTC-21. These procedures require the adjustment of trim pots on the controller's motherboard. More detailed calibration notes included in the “Neocera Temperature Controller Calibration Guide” outline the installation of calibration values in the software using the INSTRUMENT RECALIBRATE menu.

Please note that, when the top cover of the LTC-21 has been removed, dangerous high voltages are present near the power entry module, the ac power transformers and in the heater section of the motherboard. Use extreme caution to avoid these areas.

10.1. Display Contrast Adjustment

The contrast of the front panel LCD display is adjusted by the POT R14 which is located on the controller circuit board near the display connector. Adjust R14 for maximum readability on the display.

There is no brightness adjustment.

10.2. Backdoor Modes

10.2.1. Clearing Non-Volatile RAM

Clearing the non-volatile RAM in the LTC-21 will erase all user entered data and re-set the instrument to factory supplied default values. After the Clear operation is executed, the state of the instrument will be:

- Sensor Calibration data (ADC offset and gain) for the instrument will NOT be affected. This is only changed by recalibration of the LTC-21.
- All user calibration tables will be erased. Only ROM based calibration tables will be available until user tables are entered.
- PID tables, Alarm limits, Relay limits etc. will all be set to factory defaults.
- Sensor units for both channels will be set to Kelvin, Sensor type will be set to LakeShore #10 diodes. Remote interface will be set to IEEE.

To clear the non-volatile RAM, follow this procedure:

- Turn power to the LTC-21 OFF.
- Press and hold the CLEAR button of the LTC-21 while turning power ON.

- Keep the CLEAR button pressed until the ADC CAL message is seen on the LCD display.

This memory will now be cleared.

10.2.2. Entering Instrument Recalibration Mode

In order to perform calibration on the LTC-21, the instrument must be in the Instrument Recalibration Mode. Refer to the “Neocera Temperature Controller Calibration Guide” for more detailed information on instrument recalibration.

10.3. Self Test

In order to enter the Input / Output Tests Menu, proceed as follows:

- Go to the Instrument Recalibrate Menu from the Misc Menu.
- Move the cursor to the *****WARNING***** field, the word will flash.
- Press the ENTER key.

The instrument will now be in the Input / Output Tests Menu where three self tests are available. The following tests may now be performed:

- LED tests.
- Heater Output tests.
- Analog Output Channel tests.

10.3.1. LED Tests

To perform a self test of the LED indicators on the LTC-21 front panel, proceed as follows:

1. Move the cursor to the LED Test field. Press the INC key in order to change the field from OFF to ON.
2. Move the cursor to the word RUN. The word will now flash.
3. Observe the LEDs sequentially flashing on and off.

To terminate the LED test, move the cursor away from the word RUN. The word will stop flashing and the LEDs will return to their normal state.

10.3.2. Analog Output Channel Tests

To execute the Analog Output Channel self test, proceed as follows:

1. Move the cursor to the AOut Ramp field and press the INC key to toggle the field from OFF to ON.
2. Move the cursor to the word RUN. The word will now flash.
3. Using an Oscilloscope, observe a repetitious ramp on the Analog Output connector. The ramp will have peak voltages at +12V and -12V.

To terminate the test, move the cursor away from the word RUN. The word will stop flashing and the LEDs will return to their normal state.

10.3.3. Heater Output Channel Tests

To execute the Heater Output Channel self test, proceed as follows:

1. Connect a 50 Ω heater to the Heater Output Connector. Connect an Oscilloscope across the heater being careful to connect the probe ground to the LTC-21 ground pin (Heater Output Connector Pin 2).
2. Move the cursor to the Heater Ramp field and press the INC key to toggle the field from OFF to ON.
3. Move the cursor to the Heater Range field and use the INC and DEC keys to select the desired heater range.
4. Move the cursor to the word RUN. The word will now flash.
5. Using the Oscilloscope, observe a repetitious ramp on the Heater Output connector. The ramp will start at zero volts and go to a positive voltage determined by the range selected. If this is not the case, perform the Heater Power Output Channel Calibration procedure described below.

To terminate the test, move the cursor away from the word RUN. The word will stop flashing and the LEDs will return to their normal state.

10.4. Heater Power Output Channel Calibration.

Note: This procedure should only be performed if the heater channel has been repaired or is suspected of being defective. It does not affect the control accuracy of the instrument.

The calibration of the heater output channel involves a dc offset adjustment that is made to ensure that a Zero output from the heater's Digital-to-Analog converter corresponds to zero output power from the heater stage.

A DAC output voltage of less than zero volts will cause the heater output stage to output zero current. Therefore, the offset adjustment is made so that a Zero DAC output corresponds to between -.1% and -.5% of full scale. This will ensure that drift over time will not result in a condition where the heater cannot be completely turned off.

Tools required are an Oscilloscope and a trimpot adjustment tool.

To perform this calibration, proceed as follows:

1. Disconnect ac power from the instrument and remove the top cover plate.
2. Remove both sensor boards so the heater board can be easily accessed.

3. Connect the oscilloscope probe to TP9, "Htr Adj", on the heater board. Connect the probe ground to TP7, "AGnd".
4. Apply power to the instrument and turn the front panel switch ON.
5. Go the "Input / Output Tests Menu".
6. Cursor to the "Heater Ramp" field and toggle the field to ON. Leave all other tests in the OFF state.
7. Cursor to the RUN field in order to begin the Heater Ramp test. A volt sawtooth wave form should be seen on the oscilloscope at this time. The minimum voltage of the wave form should be near zero volts and the maximum near six volts. If this is not the case, the heater control circuitry is defective.
8. Adjust trimpot R9 on the heater card so that the minimum voltage on the output wave form is between -0.5mV and -30mV. If the voltage cannot be adjusted to within this range, repairs are required.

This completes the Heater Channel Calibration Procedure.

10.5. Checking Sensor Calibration

The calibration of the LTC-21 may be tested at any time using the Calibration Fixture. Simply set the instrument in the Ohms mode and read the values of high-precision resistors.

Proceed as follows:

1. Connect the Calibration Fixture to the channel being tested. Turn power to the LTC-21 ON.
2. Go to the "Setup Display" menu and select units of "Ohms".
3. To test the 6 and 2 volt input ranges (Silicon and Germanium diodes), go to the "Sensor Configuration" menu and select the "LS Diode #10" sensor.
4. Press the Monitor key. Values of the 100K Ω , 10K Ω and 1K Ω resistors should be read on the LTC-21 when selected.
5. To test the 300mV input range (Platinum Resistors), go to the "Sensor Configuration" menu and select the "Pt 1000/385" sensor.
6. Press the Monitor key. Values of the 1K Ω and 100 Ω resistors should be read on the LTC-21 when selected. Note that the instrument must perform an autorange function in this mode so it will require several seconds to stabilize to the correct reading.
7. To test the 1mV input range (i.e. for Carbon Glass Resistors), go to the "Sensor Configuration" menu and select the "CAL resistor" sensor.

- Press the Monitor key. Values of the $100\text{K}\Omega$, $10\text{K}\Omega$, $1\text{K}\Omega$ and 100Ω resistors should be read on the LTC-21 when selected. Note that the instrument must perform an autorange function in this mode so it will require several seconds to stabilize to the correct reading.

This completes instrument calibration check.

The LTC-21 Calibration fixture is comprised of a set of four precision resistors which can be switched in order to select various sensor current and voltages. A schematic of this fixture is shown below. Note: All resistors shown are 0.005%.

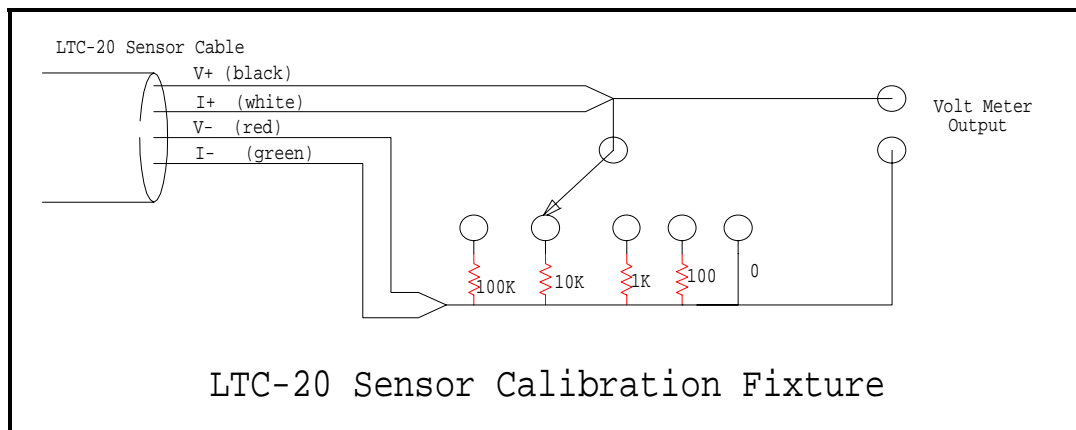

Figure 28 LTC-21 Sensor Calibration Fixture

10.6. Calibration Procedure, Sensor Channels

Refer to the “Neocera Temperature Controller Calibration Guide” for more detailed information on sensor calibration (Available from Neocera. Please call for more information).

Appendix A: Remote Interface Commands

Appendix A: Remote Interface Commands:

Remote interface commands are used for IEEE 488(GPIB) or RS232 interface. All commands are applicable for IEEE 488. Some are specific to IEEE 488 use.

These commands are broken down into 3 major types.

1. **GPIB common commands(*XXX)**. These types of commands always have a '*' as the first character and do not have a '?' as the fifth character. Not for use with RS232.
2. **Generic GPIB query commands(*XXX?)**. These types of commands always have '*' as the first character and '?' as the fifth character. Not for use with RS232.
3. **LTC device dependent commands**. If the command is not a GPIB common or GPIB query command, this function assumes it is an LTC command. e.g. SETP, QHEAT?

Some of the LTC commands have more than 1 parameter. The **separator** between the parameters is ",", and the **terminator** is ";". Spaces, CR and LF characters will be stripped out by the parser. You may use them when appropriate to make your source code more readable.

CAUTION: There is **NO** separator (,) between
the command and its first parameter!

Reference : Please refer to the *IEEE Standard Codes, Formats, Protocols and Common Commands manual (ANSI/IEEE Std 488.2-1987)* for the definition and intent of IEEE Common Commands and IEEE Common Queries.

Summary of Remote Interface Commands

<i>NAME</i>	<i>DESCRIPTION</i>
Common IEEE Commands	
*CLS	Clear Status
*ESE	Event Status Enable
*OPC	Operation Complete
*RST	Reset Command
*SRE	Service Request
*WAI	Wait-to-Continue
Common IEEE Query	
*ESE?	Event Status Enable Query
*ESR?	Event Status Register Query
*IDN?	Identification Query
*OPC?	Operation Complete Query
*SRE?	Service Request Enable Query
*STB?	Status Byte Query
Temperature Controller Commands	
SACONT	Sets ANALOG channel Control
SADDR	Sets IEEE address (0-15)
SARTBL	Sets Alarms & Relay Configuration Table
SCALT	Load a Calibration Table entry
SCONT	Set the instrument to CONTROL state.
SDLC	Sets Datalog Channel selection
SDLI	Sets Datalog sample Interval
SDLM	Sets Datalog Acquisition Mode
SDLS	Sets Datalog number of Samples
SDLT	Sets Datalog Trigger (Start/Stop)
SDUR	Sets the Input Filter Time Constant or Display Update Rate
SETP	Loads a set point for the Heater or Analog output.
SHCONT	Sets Heater channel Control
SHMPWR	Sets Heater Max Power
SLLOCK	Sets Local Lockout mode
SMON	Set the instrument to MONITOR state.

<i>NAME</i>	<i>DESCRIPTION</i>
SOSEN	Assigns output device with a sensor
SPID	Loads a PID for the Heater or Analog output.
SPTBL	Sets the PID Table entries
SPTBNDX	Set the PID Table index
SRMP	Set the Ramp parameters
SSTYPE	Assigns the Sensor channel with a specific sensor type.
STOD	Sets the Time of Date for Datalog
STUNE	Sets Manual Tune or AUTO Tune
STUNEP	Sets Autotune Parameters
SUERREG	Enables User Error Registers
SUNIT	Sets the Sensor display unit.
DCALT	Delete Calibration entry by number
QADDR?	Queries IEEE address (return a number 0-15)
QARTBL?	Queries the Alarm and Relay Table entry.
QCALT?	Queries the number of User Calibration Table entries.
QDLB?	Queries the Datalog Buffer
QDLC?	Queries the Datalog Configuration
QDUR?	Queries the input Filter Time Constant or Display Update Rate
QHEAT?	Queries the Heater output in percent of full scale power.
QISTATE?	Queries the instrument operating mode.
QLLOCK?	Queries Local Lockout mode
QOUT?	Queries the Output Configuration for the Output Channels
QPID?	Queries the PID of a channel.
QPTBNDX?	Queries the indices of PIB TABLE for the Output Channels
QRMP?	Query for the Ramp setup parameters.
QSAMP?	Query the Temperature Measurement sample
QSETP?	Query for the Heater or Analog output Set point.
QSTYPE?	Queries the Sensor channel type.
QTBL?	Queries Calibration Table settings by index (index 1 to 15 for standard)
QTOD?	Queries the Time of Date
QTUNEP?	Queries Autotune parameters
QUERREG?	Queries the User Error Registers.
QUNIT?	Queries the Sensor display unit.

Table 14 IEEE Remote Interface Commands

IEEE Command Reference

***CLS**

Format: *CLS;

LTC-21 Response: None

Description:

The Clear Status command clears the Standard Event Status Register's bit 4 and bit 5(Execution Error bit, and Command Error bit), and the content of Execution Error Register and Command Error Register. (For RS232 interface, *CLS also resets the i/o buffer pointers.)

Related Commands:

*ESE *ESE? *ESR? *SRE *SRE? *STB? SUERREG QUERREG?*ESE

***ESE**

Format: *ESE;

LTC-21 Response: None

Description:

The Event Status Enable command sets the Standard Event Status Enable Register Mask bits as defined by the IEEE 488.2-1987 standard.

Related Commands:

*CLS *ESR *ESE? *ESR? *SRE *SRE? *STB? SUERREG QUERREG?

***ESR**

Format: *ESR;

LTC-21 Response: None

Description:

The Event Status Enable command sets the Standard Event Status Register bits as defined by the IEEE 488.2-1987 standard.

Related Commands:

*CLS *ESE? *ESR? *SRE *SRE? *STB? SUERREG QUERREG?

***OPC**

Format: *OPC;

LTC-21 Response: None

Description:

The Operation Complete command sets the Standard Event Status Register's bit 0 (Operation Complete bit) when all the pending operations are completed.

Related Commands:

*OPC? *ESE *ESE? *ESR? *SRE *SRE? *STB?

***RST**

Format: *RST;

LTC-21 Response: None

Description:

The Reset command resets the temperature controller remotely. This is equivalent of turning off the temperature controller and turn on again.

Related Commands: None.

***SRE**

Format: *SRE<register enable value>;

LTC-21 Response: None

Description:

The Service Request Enable command sets the Service Request Enable Register as defined by the IEEE 488.2 - 1987 document.

Related Commands:

*SRE?

***WAI**

Format: *WAI;

LTC-21 Response: None

Description:

The Wait-to-Continue command is a synchronization command. It prevent the temperature controller from executing any further commands or queries until there is no operation pending. *Since all temperature controller commands are instantaneous executable commands, this command will be acted as an no operation command.*

Related Commands:

*OPC *OPC?

IEEE Query Command Reference

***ESE?**

Format: *ESE?;

LTC-21 Response:

One byte value, range from 0 through 255.

Description:

The Standard Event Status Enable Query requests the Standard Event Status Register Enable Mask contents in the Temperature controller. The content of the mask can be interpreted based on the IEEE 488.2 -1987 document.

Related Commands:

*CLS *ESE *ESR? *SRE *SRE? *STB? SUERREG QUERREG?

***ESR?**

Format: *ESR?;

LTC-21 Response:

One byte value, range from 0 through 255.

Description:

The Standard Event Status Enable Query requests the Standard Event Status Register content in the Temperature controller and clears it. The content of the register can be interpreted based on the IEEE 488.2 -1987 document.

Related Commands:

*CLS *ESE *ESE? *ESR? *SRE *SRE? *STB? SUERREG QUERREG?

***IDN?**

Format: *IDN?;

LTC-21 Response:

A string of characters in the form of "Neocera Model LTC-21 *version*".

Description:

The Identification Query requests the device identification. The intent is for the controlling device to determine the unique identification of devices on the bus.

Related Commands:

*RST

***OPC?**

Format: *OPC?;

LTC-21 Response:

An ASCII character of 1;

Description:

The Operation Complete Query returns a '1' when all the pending operations are completed.

Related Commands:

*OPC *ESE *ESE? *ESR? *SRE *SRE? *STB?

***SRE?**

Format: *SRE?;

LTC-21 Response:

One byte value, range from 0 through 63 or 128 through 191.

Description:

The Service Request Enable query requests for the Service Request Enable Register content. The content are defined by the IEEE 488.2 - 1987 document.

Related Commands:

*SRE

***STB?**

Format: *STB?;

LTC-21 Response:

One byte value, range from 0 through 63 or 128 through 191.

Description:

The Read Status Byte query requests for the Status Byte Register content. The content are defined by the IEEE 488.2 - 1987 document.

Related Commands:

*CLS *ESE *ESR? *SRE *SRE?

LTC-21 Commands Reference

SACONT

Format: SACONT<3=PID , 4=TABLE, 5=DEFAULT, 6=MONITOR>;

LTC-21 Response: None

Description:

Sets the Analog output channel's control information.

Output	Index	Control
Analog	3	PID
	4	TABLE
	5	DEFAULT
	6	MONITOR

Table 15 IEEE Analog Output Channel Control Information

Related Commands:

QOUT?

SADDR

Format: SADDR<0-31 or 232>;

LTC-21 Response: None

Description:

Set the IEEE (GPIB) address for the instrument. This number must be a value from 0 to 31. The system default is 15. To set the instrument to RS232, "SADDR 232;" will do the initial switch from IEEE to RS232. Baud rate is assumed to be 9600.

Related Commands:

QADDR?

SARTBL

Format:SARTBL<1=Sensor #1,2=Sensor #2>,
<0=Alarm,1=Relay>,<0=Armed,1=Disarmed>,
<Hi limit>,<Lo Limit>;

LTC-21 Response: None

Description:

Sets the Alarm table's or Relay table's Low and High limit and their Arm and Disarm functions. While the Alarm or the Relay are armed, when the measurement for the sensor device exceeds the high limit or falls below the low limit, the alarm/relay will be set until the measurement falls within the limit or the device is disarmed. The units of the High or Low limit are based on the units set by the SUNIT command.

Related Commands:

QARTBL? SUNIT QUNIT?

SCALT

Format: SCALT<Sensor Type: 0=2V Diode, 1=6V Diode, 2=R250, 3=R2500, 4=R1.0M AC>,<Volt. Bias 0=10mV, 1=3mV (additional ranges for *Enhanced LTC-21*: 2=1mV, 3=320uV,4=100uV,5=32uV,6=10uV)> <Calibration table units 0 =LogOhms, 1=Ohms, 2=Volts>, <Cal table description, up to 19 ASCII characters>,<Cal table multiplier>, <temperature>, <voltage or ohms>, <temperature>, <voltage or ohms> , ...up to 149 pairs of temp and voltage or ohms entries..., <terminator=\$>;

LTC-21 Response:

None.

Description:

Loads a user defined calibration table into the system memory. *During the downloading of a long user calibration table (over 10 entries), the LTC needs to process each entry individually. Depending on the speed of the host which downloads the table, a Transmit overflow error might occur. We recommend using a delay function between some of the entries.* Be sure not to use TAB characters in the SCALT command, otherwise an error may occur.

Entry Name	Parameters				
Sensor Type	0 = 2V Diode	1 = 6V Diode	2 = R250	3 = R2500	4 = R1.0 mV
Voltage Bias	0 = 10mV	1 = 3mV	2 = 1mV	3 = 320uV	4 = 100uV
	5=32uV	6=10uV			
Cal Table Units	0 = LogOhms	1 = Ohms	2 = Volts		
Sensor Description	1 to 19 characters	(Spaces will be eliminated)			
Multiplier	A non-zero				
2 to 149 Entries	T(K),	Volts/Ohms pairs			
terminator	\$				

Table 16 IEEE Sensor Calibration Selections

Related Commands:

QCALT? QTBL?

SCONT

Format: SCONT;

LTC-21 Response: None.

Description:

Control command. This command sets the instrument to "control" mode. Temperature monitor and heater control are both continuously applied in this mode.

Related Commands:

QISTATE? SMON STUNE

SDLC

Format: SDLC<1 = Sensor #1,
2 = Sensor #2,
3 = Sensor #1 and Sensor #2>;

LTC-21 Response: None.

Description:

Sets the Datalog channel selection.

Related Commands:

QDLC? SDLI SDLS SDLM SDLLT

SDLI

Format: SDLI <1 = 1 second,
10 = 10 seconds,
60 = 1 minute
300 = 5 minutes
600 = 10 minutes>;

LTC-21 Response: None.

Description:

Sets the Datalog Interval selection.

Related Commands:

QDLC? SDLC SDLS SDLM SDLT

SDLM

Format: SDLM <0 = Oneshot>, <1 = Cyclical>;

LTC-21 Response: None.

Description:

Sets the Datalog Acquisition mode selection.

Related Commands:

QDLC? SDLC SDLS SDLI SDLT

SDLS

Format: SDLS <4 to 500>;

LTC-21 Response: None.

Description:

Sets the Datalog buffer size.

Related Commands:

QDLC? SDLC SDLI SDLM SDLT

SDLT

Format: SDLI <0 = stop datalog, 1 = start datalog>;

LTC-21 Response: None.

Description:

Sets the Datalog Interval selection.

Related Commands:

QDLC? SDLC SDLS SDLM SDLT

SDUR

Format: SDUR <0 = 0.5 sec., 1 = 1 sec. , 2 = 2 sec, 3 = 4 sec. , 4 = 8 sec., 5 = 16 sec. >;

LTC-21 Response: None.

Description:

Sets the Input Filter Time Constant or Display Update Rate index.

Related Commands:

QDUR?

SETP

Format: SETP <1=HEATER, 2=ANALOG>,<setpoint in specified unit>;

LTC-21 Response: None.

Description:

Loads a set point for the Heater or Analog output.

Related Commands:

QSETP?

SHCONT

Format: SHCONT<0=AUTO P,

1=AUTOPI,

2=AUTOPID,

3=MAN,

4=TABLE,

5=DEFAULT>;

LTC-21 Response: None.

Description:

Sets the Heater output channel Control Mode selection.

Output	Index	Control
Heater	0	AUTO P
	1	AUTO PI
	2	AUTO PID
	3	PID (manual)
	4	TABLE
	5	DEFAULT

Table 17 IEEE Heater Output Channel Control Mode Selection

Related Commands:

QOUT? QHMPWR? SHMPWR STUNE

SHMXPWR

Format: SHMXPWR< index 0 to 4 >;

LTC-21 Response: LTC-21 will exit the CONTROL or MONITOR loop to safeguard against heater range change. You can restore the LTC-21 to MONITOR or CONTROL mode after this command by issuing SMON or SCONT respectively.

Description:

Sets the Heater output channel Maximum Heater Power selection. The heater output percentage is based on the Maximum Heater Power selection.

Output	Index	Max Power
Heater	0	Off
	1	0.05W
	2	0.5W
	3	5W
	4	50W

Table 18 IEEE Maximum Heater Output Selection

Related Commands:

QOUT?

SLLOCK

Format: SLLOCK<0 = no lockout, 1 = local lockout>;

LTC-21 Response:

Whenever a data transmission occurs on the remote interface(ether GPIB or RS232), LTC-21 will set the Local Lockout mode, disable the front panel, and light the **REM** LED, until the **LOCAL** key is pressed or SLLOCK 0 command is invoked from the remote I/O.

Description:

Sets the local lockout mode. Local lockout disables the front panel keyboard. Pressing the **LOCAL** key on the front panel will re-enable the rest of the front panel keys. The Local Lockout function prevents users from inadvertently altering instrument settings while the remote interface is active.

Related Commands:

QLLOCK?

SMON

Format: SMON;

LTC-21 Response: None.

Description:

Monitor command. This command places the instrument into the "Monitor" mode. Temperature is continuously monitored, but no heater control is applied. This command will terminate the temperature control and Autotune functions, if in progress.

Related Commands:

QISTATE? SCONT STUNE

SOSEN

Format: SOSEN<1=Heater,
2=Analog>,
<1=Sensor#1, 2=Sensor#2, 3= NONE>;

LTC-21 Response: None

Description:

Assigns a sensor to source the HEATER or ANALOG output.

Related Commands:

QOUT?

SPID

Format: SPID< 1 = Heater, 2 = Analog >, (*and...*)

<P Gain 1-1000>, <I Gain 1-10000>,
<D Gain 1-1000 (but not greater than I/2)>,<P0 Manual Percent term>,
<Power Limit Percentage>; (*for Heater*)
(*or . . .*)

<P Gain1-1000>, <I Gain1-10000>,
<D Gain 1-1000 (but not greater than I/2)>,<P0 Manual Percent term>,
<Analog Out Gain>, <Analog Out Offset>; (*for Analog Output*)

LTC-21 Response: None

Description:

Loads a PID and Power Limit for the HEATER, or PID and Gain & Offset for ANALOG output when the Output control mode is set to PID mode.

Related Commands:

QPID? SHCONT SACONT QOUT?

SPTBL

Format: SPTBL<PID Table Index = 1 to 5>,
<Set Point 1>, <P1>, <I1>,<D1>,<P0 1>, <TPMAX = index 0 to 4>,
<Set Point 2>, ...
<Set Point 10>, <P10>, <I10>,<D10>,<P0 10>, \$;

LTC-21 Response: None.

Description:

Sets the PID Table entries. Set points in table must be in descending order or else the table will be rejected. Not all entries have to be entered. Enter \$ to be the terminator. Spaces and new line characters can be used before and after ", ". No TAB characters are allowed.

Related Commands:

SPTBNDX, SACONT, SHCONT, QPTBNDX

SPTBNDX

Format: SPTBNDX< 1 = Heater, 2 = Analog >, <PID Table Index = 1 to 5>

LTC-21 Response: None.

Description:

Select one of the 5 PID tables for this output channel when utilizing TABLE mode. This should be done before the output mode is set to the TABLE mode (see SHCONT or SACONT commands). If this is not set, the last index (which is 1 when system is initialized) used from the front panel will be used.

Related Commands:

QPTBNDX, SHCONT, SACONT

SRMP

Format: SRMP<channel>, <armed>,<setpoint>,<degrees/minute>;

LTC-21 Response: None.

Description:

Sets ramp parameters. Example: SRMP1,1,300.0,10; This sets channel 1 to ramp to 300.0K at 10K/minute.

Related Commands:

QRMP?

STOD

Format: STOD<Hour>,

LTC-21 Response: None.

Description:

Sets the Datalog current Time entry.

Related Commands:

QTOD?

SSTYPE

Format: SSTYPE<1 = Sensor 1 or 2 = Sensor 2>,

<Standard Sensor Type 1 - 15 or User Sensor Type 16 to 25>;

LTC-21 Response: As a precaution, the LTC will switch from CONTROL or MONITOR mode to OFF mode.

Description:

Assigns the Sensor channel with a specific sensor type.

Sensors Type	Descriptions
1	LS DIODE #10
2	CryoCal D3
3	SI-410NN
4	LS TG-120
5	PT 100/385
6	PT 1000/385
7	PT 100/392
8	PT 1000/392
9	Cal Res 10mV
10	Cal Res 3mV
11	Cal Res 1mV
12	Cal Res 320 μ V
13	Cal Res 100 μ V
14	Cal Res 32 μ V
15	Cal Res 10 μ V
16	USER TABLES HERE

Table 19 IEEE Sensor Type Selection

For a user defined table, the index into the user table is added to 10. User table 1 is 1+10, and user table 5 is 15 etc.

Related Commands:

QSTYPE? SCALT QCALT? QTBL?

STUNE

Format: STUNE<0=Manual, 1= Autotune>;

LTC-21 Response: None.

Description:

Changes the instrument tune state to MANUAL or AUTOTUNE state. If AUTOTUNE is selected and when the instrument is in CONTROL mode, the instrument will use the existing PID settings to regulate the system and Autotune the system to obtain new PID settings. This process of seeking a new PID setting is called TUNING. While the system is in AUTOTUNE state, the temperature controller will change the heater settings and measure the temperature response in order to determine the thermal characteristics of the system. Once the new PID settings are obtained, the temperature setting for the system will regulate using the new PID. It should be the optimal PID setting for this temperature in this thermal system. If a new set point is subsequently given, the system will automatically tune to get a new optimal PID setting for the new set point. If MANUAL is selected, the instrument will regulate the temperature setting using the existing PID setting or as specified by the SPID command. SHCONT command must be issued to set the heater control to AUTOPID, AUTOPI, or AUTOP mode before this command can have any effect.

Related commands:

SCONT, SMON, SPID, ISTATE?

STUNEP

Format: STUNEP<1 = System Response, 2 = Tuning Temperature Deviation>,

<System Response: S or 0 = Slow, N or 1 = Normal, F or 2 = Fast System Response>; or

<Tuning Temperature Deviation: 0.1 to 50 = Tuning Temperature Deviation percentage>;

LTC-21 Response: None.

Description:

Setting the system response time and deviation temperature for Autotune use.

System response time denotes the cryogenic system response time. A fast system responds rapidly to the heat applied to it. A slow system will have a time lag response. Please refer to section 8.1 Autotuning for description. The system default is set to normal.

Tuning temperature deviation denotes whether the system should automatically retune to obtain a new set of PID coefficients when the user changes the set point. If the new set point deviates from the last autotuning temperature by the tuning temperature deviation percentage, the system will go into retune to obtain a new set of PID coefficients. Any value less than 0.1% will always retune when a new setpoint is entered.

Related commands:

QTUNEP?

SUERREG

Format: SUERREG<1=Command Error Register,
2=Execution Error Register>,
<Register setting>;

LTC-21 Response: None.

Description:

Sets the User Error Register enable bits. The register value will be evaluated as a decimal number. User Error registers are internal to the LTC. The enable bits are normally set to zero. When a particular error condition occurs, if the enable bit for that condition is enabled, the specific GPIB Standard Event Status Register bits will be set accordingly (bit 5 of ESR for command, bit 4 of ESR for Execution).

Bit 7	Bit 6	Bit 5	Bit 4	Bit 3	Bit 2	Bit 1	Bit 0
Not Used	Not Used	Not Used	Not Used	Not Used	Bad Parameter	Unterminated Command	Unknown Command

Table 20 IEEE SUERREG Command Error Register Bit Definition

Bit 7	Bit 6	Bit 5	Bit 4	Bit 3	Bit 2	Bit 1	Bit 0
Not Used	Not Used	Not Used	Transmit Buffer Overflow	Parity Error	Unknown GPIB Error	Receive Buffer Overflow	Transmit Buffer Under flow

Table 21 IEEE SUERREG Execution Error Register Bit Definition

Related Commands:

QUERREG? *ESE *ESE? *ESR?

SUNIT

Format: SUNIT<1 = Sensor 1 or 2 = Sensor 2>,<K or C or F or N or V or O>;

LTC-21 Response: None.

Description:

Sets the sensor channel display unit to Kelvin, Celsius, Fahrenheit, No sensor, Volts, or Ohms. The units can also use <0 or 1 or 2 or 3 or 4 or 5>.

Related Commands:

QSUNIT?

DCALT

Format: DCALT<index>;

LTC-21 Response: None

Description:

Deletes the user calibration table entry by index. The index will be checked to be within the valid number of user calibration table entries created.

Related Commands:

SCALT QCALT? QTBL?

QADDR?

Format: QADDR?;

LTC-21 Response:

One byte containing the GPIB address of the instrument. The content will be between 0 and 31 inclusive.

Description

Inquire about the current IEEE (GPIB) address setting for the instrument. This number must be of the value between 0 to 31 decimal.

Related Commands:

SADDR

QARTBL?

Format: QARTBL?<0 for Alarm Tables, 1 for Relay Tables>;

LTC-21 Response:

Two sets of three parts: First byte is 0 if Armed, 1 if disarmed. Second character string is the High limit in 10 characters of number(with unit for Volts or Ohms), and third character string is the Low limit setting in 10 characters of number(with unit for Volts or Ohms).

Description:

Request the Alarm or the Relay table settings.

Related Commands:

SARTBL

QCALT?

Format: QCALT?;

LTC-21 Response:

One to two characters of the value of 0 to 16.

Description:

Request the number of *user* calibration tables. Returns the number of User calibration tables created. e.g. 2 means two user calibration tables in memory.

Related Commands:

SCALT QTBL?

QDLB?

Format: QDLB? <Buffer number>;

LTC-21 Response:

One character string of datalog consists of the time of day of datalog, sensor data, heater power. If SDLC is set for Both, it will show both channels' data.

Description:

Read one datalog buffer at one time. For multiple data buffer read, send multiple data buffer commands.

Related Commands:

SDLI SDLC SDLS SDLM SDLT

QDLC?

Format: QDLC?;

LTC-21 Response:

Four ASCII character strings for datalog interval, channel selection, number of samples, and acquisition mode, one ASCII number for datalog trigger.

Description:

Datalog configuration.

The first string is an eleven characters datalog interval

" 1 Second "

"10 Seconds"

" 1 Minute "

" 5 Minutes"

"10 Minutes"

The second string is a four character datalog channel selection

"#1 " = Sensor #1 and Heater Power

"#2 " = Sensor #2 and Heater Power

"Both" = Sensor #1 and Sensor #2 Readings

The third string is a five character number of samples for datalog (buffer size), 4 to 500.

" 4" to " 500"

The fourth string is an eight character acquisition mode.

"One Shot"

"Cyclical"

The fifth number is the datalog trigger.

0 = stop datalog

1 = start datalog

Related Commands:

SDLI SDLC SDLS SDLM SDLT

QDUR?

Format: QDUR?;

LTC-21 Response:

An ASCII string of numbers, 0.5 for 0.5 seconds, 1, 2, 4, 8, 16 for respective seconds.

Description:

Queries the Input Filter Time Constant or Display Update Rate.

Related Commands:

SDUR

QHEAT?

Format: QHEAT?;

LTC-21 Response:

An ASCII string of no more than 5 characters, signifying the percentage of heater full scale. 0 indicates the heater is turned off at the time of query, and 100.0 indicates full scale.

Description:

Determines the HEATER percent of full scale power. The Heater Power setting is programmed by the SHMXPWR command. While the instrument is in Monitor mode, the heater output is turned off.

Related Commands:

SHCONT SOCONT SHMXPWR SCONT

QISTATE?

Format: QISTATE?;

LTC-21 Response:

One character byte containing instrument state.

Description:

Queries the instrument state. A single character which is interpreted as follows:

- 0 Temperature Control is in MONITOR mode.
- 1 Controller is in CONTROL mode.
- 2 Autotune is in progress.
- 3 Controller is in OFF mode. (No temperature display).

Related Commands:

SMON SCONT STUNE

QLLOCK?

Format: QLLOCK?;

LTC-21 Response:

One byte ASCII number of 0, or 1. 0 is no lockout. 1 is local lockout.

Description:

Queries the instrument for the local mode setting.

Related Commands:

SLLOCK

QOUT?

Format: QOUT?<Heater = 1 or Analog = 2>;

LTC-21 Response:

Two coded byte for Analog output, and Three coded byte for Heater.

Description:

Queries the Output Configuration for the Output Channels.

The first byte is interpreted as:

- 1 = Sensor #1
- 2 = Sensor #2
- 3 = No Sensor assigned

The second byte is interpreted as:

- 0 = AUTO P
- 1 = AUTO PI
- 2 = AUTO PID
- 3 = PID
- 4 = TABLE
- 5 = DEFAULT
- 6 = MONITOR

The third byte is only available for the HEATER, it is interpreted as:

- 0 = Off
- 1 = 0.05W
- 2 = 0.5W
- 3 = 5 W
- 4 = 50W

Related Commands:

SHCONT SACONT

QPID?

Format: QPID?<1=HEATER, 2= ANALOG>;

LTC-21 Response:

Four ASCII character strings each representing a floating point number. They are the Proportional gain constant(P gain), Integration gain constant(I gain), Derivative gain constant(D gain) and the percentage of fixed power reset term (Fixed power settings).

For Heater output, one additional character string is also provided: Power Limit Percentage.

For Analog output, two additional character strings are also provided: Gain and Offset.

Description:

Queries for the PID. Determines the PID for the Heater or Analog output channels.

Related Commands:

SPID

QPTBNDX?

Format: QPTBNDX?;

LTC-21 Response:

Two ASCII character numbers indicating the indices of PID Tables set for Heater and Analog channel if TABLE mode is selected.

Description:

Two ASCII character number indicating the indices of PID Tables set for Heater and Analog channel if TABLE mode is selected.

Related Commands:

SPTBNDX, SACONT, SHCONT

QRMP

Format: QRMP?<channel>;

LTC-21 Response: <armed>,<Ramp temperature setpoint>,<degrees/minute>;

Description:

Example: 1,300.000,10;

Related Commands:

SRMP?

QSAMP?

Format: QSAMP?<1=Sensor 1, 2= Sensor 2>;

LTC-21 Response:

String of eleven ASCII characters, containing a measurement and unit from a sensor.

Description:

This command requests the temperature measured by sensor 1 or 2. The measurement unit is included as the last character. If the measurement is -1.00, this indicates an overrange or underrange condition. These conditions can occur if the instrument is in the process of an ADC calibration or the instrument sensor is not assigned or connected.

Related Commands:

SETP SOSEN SUNIT QUNIT?

QSETP?

Format: QSETP?<1=HEATER or 2=ANALOG>;

LTC-21 Response:

String of eleven ASCII characters, containing a setpoint and associated unit.

Description:

Queries the Heater or Analog outputs to determine the set point.

Related Commands:

SETP QHEAT?

QSTYPE?

Format: QSTYPE?<1 = Sensor #1 or 2 = Sensor #2>;

LTC-21 Response:

String of characters as the description of the sensor as given in the standard or user defined calibration tables.

Sensors Type index	Standard Cal Table Descriptions
1	LS DIODE #10
2	CryoCal D3
3	SI-410NN
4	LS TG-120
5	PT 100/385
6	PT 1000/385
7	PT 100/392
8	PT 1000/392
9	Cal Res 10mV
10	Cal Res 3mV
11	Cal Res 1mV
12	Cal Res 320 μ V
13	Cal Res 100 μ V
14	Cal Res 32 μ V
15	Cal Res 10 μ V
16	USER TABLES HERE

Table 22 IEEE Standard Cal Table/Sensor Type Indices

Description:

Inquire the type of sensor for the specific sensor channel.

Related Commands:

SSTYPE

QTBL?

Format: QTBL?<index = 1 to 10 or 10 + number of user Calibration table entries>;

LTC-21 Response:

A string of 5 entries separated by ";".

Description:

Query the contents of the standard and user calibration tables.

Entry Name	Response	Parameters		
Sensor Type	string	"Diode 2V"	"Diode 6V"	"R250 DC"
		"R2500 DC"	"R1.0M AC"	
Cal Table Units	1 character	0 = LogOhms	1 = Ohms	2 = Volts
Multiplier	A non-zero			
Sensor Description	1 to 19 bytes	1 to 19 characters		
Voltage Bias	string	"10mV"	"3mV"	
		"1mV"	"320µV"	"100µV"
		"32µV"	"10µV"	

Table 23 IEEE Standard and User Tables Contents

Related Commands:

SCALT

QTOD?

Format: QTOD?;

LTC-21 Response:

One ASCII string of HH:MM:SS where

HH is the Hour of day

MM is the Minutes

SS is the Seconds

Description:

Queries the current time.

Related Commands:

STOD

QTUNEP?

Format: QTUNEP?<1 = System Response, 2 = Tuning Temperature Deviation>;

LTC-21 Response:

For system response, one ASCII character:

- S - Slow;
- N - Normal;
- F - Fast;

For Tuning Temperature Deviation Setting, a number representing the percentage of deviation. 0.50 is 50%..

Description:

Queries the Autotune parameter settings.

Related Commands:

STUNEP STUNE

QUERREG?

Format: QUERREG?<1=Command Error Register, 2=Execution Error Register>;

LTC-21 Response:

One byte reply of the register content in ASCII decimal.

Description:

Queries the User Error registers. This command will also clears the register content.

Bit 8	Bit 7	Bit 6	Bit 5	Bit 4	Bit 3	Bit 2	Bit 1
Not Used	Not Used	Not Used	Not Used	Not Used	Bad Parameter	Unterminated Command	Unknown Command

Table 24 QUERREG? Command Error Register Bit Definition

Bit 8	Bit 7	Bit 6	Bit 5	Bit 4	Bit 3	Bit 2	Bit 1
Not Used	Not Used	Not Used	Transmit Buffer Overflow	Parity Error	Unknown GPIB Error	Receive Buffer Overflow	Transmit Buffer Under flow

Table 25 QUERREG? Execution Error Register Bit Definition

Related Commands:

SUERREG

QUNIT?

Format: QSUNIT?<1=Sensor#1, 2=Sensor#2>;

LTC-21 Response:

Single character reply of K or C or F or N or V or O.

Description:

Query the display unit for channel 1 or 2.

Related Commands:

SUNIT

Appendix B

IEEE 488.2 Example Programs

Appendix B: IEEE 488.2 Example Programs

The following example C language program illustrates how to access and operate the LTC-21 from a remote computer using the IEEE-488.2 interface. This program uses a computer to access, query, and control various LTC-21 functions. The NATIONAL INSTRUMENTS AT-GPIB controller and NI-488.2™ MS-DOS Handler were used with the following code.

DISCLAIMER
THIS IN NO WAY CONSTITUTES A REPRESENTATION OR
RECOMMENDATION OF NATIONAL INSTRUMENTS PRODUCTS. PLEASE
CONTACT NATIONAL INSTRUMENTS DIRECTLY REGARDING QUESTIONS
ABOUT NATIONAL INSTRUMENTS PRODUCTS.

```
/* TEST.C 02-92
   Test TC GPIB program
*/
#include <stdio.h>
#include "decl.h"
#include <string.h>
#include <time.h>
int PC_handle,TC_handle;
/* TC_handle - Temperature Controller device "ud" */
/* PC_handle - the PC's gpib board device "ud" */

char rec_string[200];
char send_string[100];

#define TRUE 0
#define FALSE 1

int send_TC(char *str);
int init_TC_GPIB(void);
int receive_TC(char *str,int max_num_char);
void putmsg(char *str);

main()
{
    int ok,i,string_length;
```

Model LTC-21 Cryogenic Temperature Controller

```
char timebuf[24], datebuf[24];

printf("Initializing... \n");
init_TC_GPIB();
printf("Request for Device Identification: ");
putmsg("*IDN?;");
printf("\nGet Current State of Temperature Controller---\n");
printf("Instrument State: 0-Monitor,1-Control,2-AUTOTUNE\n");
putmsg("QISTATE?;");
printf("GPIB Address should be 15 \n");
putmsg("QADDR?;");
printf("Local Lockout: 0-No Lockout, 1-Lockout\n");
putmsg("QLLOCK?;");
putmsg("QHEAT?;");
putmsg("QOUT?1;"); putmsg("QOUT?2;"); /* Output Configuration */
putmsg("QSAMP?1;"); putmsg("QSAMP?2;");
putmsg("QSTYPE?1;"); putmsg("QSTYPE?2;");
putmsg("QUNIT?1;"); putmsg("QUNIT?2;");
putmsg("QPID?1;"); putmsg("QPID?2;");
putmsg("QSETP?1;"); putmsg("QSETP?2;");
putmsg("QCALT?;");
putmsg("QARTBL?0;");
putmsg("QARTBL?1;"); /* 0 Alarm, 1 Relay */

putmsg("QTBL?1;"); putmsg("QTBL?2;"); putmsg("QTBL?3;");
putmsg("QTBL?4;"); putmsg("QTBL?5;"); putmsg("QTBL?6;");
putmsg("QTBL?7;"); putmsg("QTBL?8;"); putmsg("QTBL?9;");

printf("\nTry some set commands...\n");

putmsg("SACONT3;"); putmsg("QOUT?2;"); /*Set Analog Control to DEFAULT */
putmsg("SARTBL1,0,0,111.11,11;SARTBL2,0,0,222.22,22;"); /* Alarm Tbl */
putmsg("QARTBL?0;");
putmsg("SCONT;");
printf("Instrument State: 0-Monitor,1-Control,2-AUTOTUNE\n");
putmsg("QISTATE?;");
putmsg("SETP1,111.44;"); putmsg("QSETP?1;");
putmsg("SARTBL1,0,1,111.11,11;"); /* Alarm Tbl */
putmsg("SARTBL2,0,1,222.22,22;"); /* Alarm Tbl */
putmsg("QARTBL?0;");
putmsg("SHMXPWR3;"); /*Heater Max Power is now 5w */
putmsg("SOSEN1,1;SOSEN2,2;"); /*Output Sensor -Heater #1, ANA #2*/
putmsg("SHCONT4;"); /*Set HEATER Control to PID */
putmsg("QOUT?1;"); putmsg("QOUT?2;");
putmsg("SOSEN1,1;SOSEN2,3;"); /*Output Sensor -Heater #1, ANA NONE*/
```

Model LTC-21 Cryogenic Temperature Controller

```
putmsg("QOUT?1;"); putmsg("QOUT?2;");

putmsg("SPID1,150,25,6,0;"); putmsg("QPID?1;");
putmsg("QSTYPE?1;"); putmsg("SSTYPE1,4;"); putmsg("QSTYPE?1;");
putmsg("QSTYPE?2;"); putmsg("SSTYPE2,2;"); putmsg("QSTYPE?2;");
putmsg("QUNIT?1;"); putmsg("SUNIT2,F;"); putmsg("QUNIT?2;");
putmsg("SMON;");

printf("\n----- End of Test -----\n");
/* Display DOS-style date and time. */

    _strtime(timebuf);
    _strdate(datebuf);

    printf("This GPIB test for LTC 20 is done on %s, %s\n\n", timebuf, datebuf);

} /* end main */

int init_TC_GPIB(void)
{
    /* initializes the TC box */
    PC_handle = ibfind("GPIB0");
    TC_handle = ibfind("DEV15");
    ibtmo(TC_handle,11);
}

int receive_TC(char *str,int max_num_char)
{
    int i;

    ibrd(TC_handle,str,max_num_char); /*read string from TC*/
    /* put terminator on end of string */
    str[ibcnt] = '\0';
} /* end function receive_TC */

int send_TC(char *str)
{
    int i, j;
    j = 0;

    ibwrt(TC_handle,str,strlen(str)); /*write string to TC*/

    for (i = 1; i < 15000; i++)
```

Model LTC-21 Cryogenic Temperature Controller

```
        {
            /* wait loop for Setting up Cal Tables */
            j = i + j - 1; /* counting fingers - 1, 2, 3, */
        }

} /* end function send_TC */

void putmsg (char *str)
{
    int i, j;
    j = 0;
    ibwrt(TC_handle, str, strlen(str)); /*write string to TC*/
    for (i = 1; i < 9000; i++)
    { /* wait loop for setting up long commands */
        j = i + j - 1;
    }
    if((str[0] == 'S') || (str[0] == '*' && str[4] != '?')){
        printf("Msg Sent:--%s \n", str);
        return;
    }
    receive_TC(rec_string, 100);
    printf("Msg Sent:--%s \tMsg Received: %s--\n", str, &rec_string);
    return;
} /* of putmsg */
/* end of test.c */
```

Appendix C

Interface Connector Pinouts

Appendix C: Interface Connector Pinouts

Relays

Relay uses an AMP 8 pin receptacle. The mating plug is an AMP 206434-1.

Connector face view with pin assignments are shown below.

Relay	Normally Closed	Common	Normally Open
1	pin 8	pin 7	pin 6
2	pin 5	pin 4	pin 3

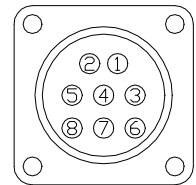

Table 26 Relay Connector Pin-out

Sensors

Sensors use a LEMO 4 connector (FGG.1B.304.CNAD52). When assembling this connector, ensure that the cable shield is firmly connected to the connector metal shell.

Note also that a sensor and cable assembly is available from NEOCERA Instrument and Systems Group.

Connector face view with pin assignments are shown below.

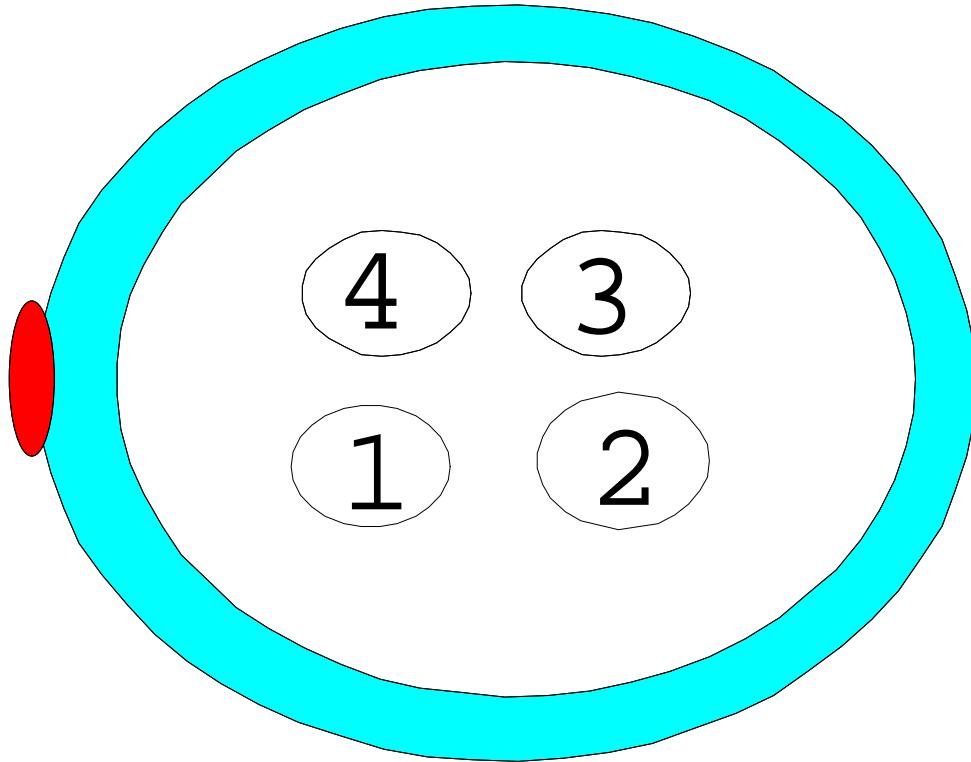

Pin Number	Signal Name	Color Code
1	Sense In+ (V+)	Black
2	Sense in- (V-)	Red
3	CCS Ground (I-)	Green
4	CCS OUT (I+)	White

Table 27 Sensor Connector Pin-out

Color codes shown are for a Belden 8723 type cable. In all cases, a shielded twisted pair cable should be used.

On the instrument end of the sensor cable, the shield connection is made via the connector body.

On the sensor end of the cable, the shield should be connected to a non-current carrying earth ground whenever possible. If no such ground is available, the shield should be left disconnected. Never connect a shield to a current carrying conductor.

While using a Platinum sensor, the polarity of the connection terminals is not important. However, when a Diode type sensor is used, the Anode must be connected to the positive terminal and the Cathode must be connected to the negative terminal.

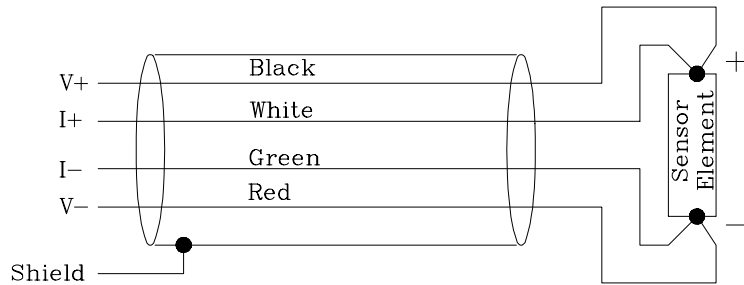

Figure 29 Platinum Sensor Four-wire Connection

Example Diode Sensor Connections

The proper connection for a LakeShore™ DT-470 diode is shown to the right. This connection may be used for the DT-470, DT-471 or DT-450 type diodes.

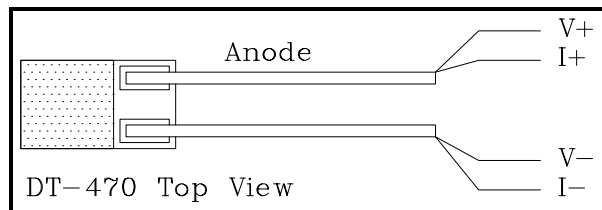

Figure 30 DT-470 Sensor Four-wire Connection

Many of the CryoCal™ Silicon Diodes have four color coded leads. They are connected as follows:

Diode wire color	Name	Cable wire color
White	I+	White
Yellow	V+	Black
Green	V-	Red
Black	I-	Green

Table 28 CryoCal™ Silicon Diodes Wire Color Codes

Analog Output:

The Analog Output uses a AMP 4 pin connector. The mating plug is AMP 206429-1.

Connector face view with pin assignments are shown below.

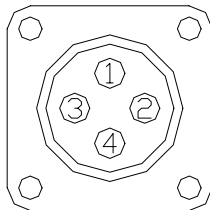

Pin	Signal
1	Output+
2	Output-
3	Chassis GND
4	NC

Table 29 Analog Output Pin-out

Heater:

The Heater Output uses an AMP 9 pin connector. The mating plug is AMP #211400-1.

Connector face view with pin assignments are shown below (pins 3-7 are unused).

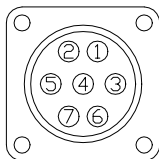

Pin Number	Signal Name	Color Code
1	HTR +V	Red
2	HTR GND	Black
3	Chassis GND	Green
4-7	NC	

Table 30 Heater Connector Pin-out

Appendix D: Application Notes

Procedure to interface with LTC-21 using Windows 3.1 Terminal

LTC-21 Setup

1. Turn on LTC-21
2. Select SETUP/MISC/REMOTE INTERFACE
3. Toggle Remote I/O Selection to RS232
4. Select Baud rate - 9600 is the default (Baud rates greater than 9600 may not work with Windows 3.xx)
5. EXIT/EXIT

Make sure the RS232 cable is connected between the PC and the LTC

On your PC, run Windows 3.xx and then select the Terminal program (Terminal.exe). From the Terminal menu, make the following selections.

Settings — Communications to

Baud Rate	9600
-----------	------

Data Bits	8
Stop Bits	1
Parity	None
Flow Control	Xon/Xoff
Connections	Com1/Com2

Table 31 RS-232 Settings

Terminal Preferences to

Terminal Modes	Local Echo
CR-> CR/LF	Outbound

Terminal Emulation select **DEC VT-100 (ANSI)**

Text Transfers select either **One Line at a time** or **One Character at a time**

When you finish, you may save your settings to a file by selecting **File — Save-As** and a file name. (the next time you run Terminal from Windows, just open this file to have all your settings restored.)

If the LTC is powered on, and the RS232 cable is connected to LTC from the proper COM port, your PC should be ready to communicate with the LTC. Start by typing in:

***OPC?;**

Do not use any backspaces or tabs, or the parser will interpret them as characters and flag an error (if the LTC emits a beep, it has encountered an error). The Terminal program should display the response:

1;

followed by a carriage return. If this doesn't happen, try a few more times. Remember, back spaces and tabs should not be used. You may need to enter:

***CLS;**

to clear the system buffers. If you are not receiving any characters from the LTC, check the cable connections, and COM port settings.

Once you have established a connection, try the following query commands to see how the LTC responds:

***IDN?;**

QPID?1;

QSAMP?1;

QUNIT?1;

QISTATE?;

QOUT?1;

You can use the terminal program to download calibration tables to the LTC. Create a .txt file with the calibration table in the SCALT command format (see appendix A or example below).

From the Terminal program menu, select **Transfers — Send Text File ...** and select the calibration text file. Click OK to send the contents of your text file to the LTC.

Model LTC-21 Cryogenic Temperature Controller

If you create your text file in another program (a spread sheet for instance), be sure to strip out any tab characters the program may use. If your calibration table has more than a few temperature/voltage pairs, you may need to send the table in smaller sections to avoid overflowing the LTC's input buffer.

A user defined calibration table might appear as follows:

SCALT0,0,0,Custom Diode,-1.0,

475,0.09062,

470,0.10191,

460,0.12547,

440,0.17464,

380,0.32416,

340,0.42221,

290,0.54294,

240,0.66208,

210,0.73238,

180,0.80138,

150,0.86873,

131.38,0.912,

106.56,0.95487,

86.058,0.99565,

75.876,1.01525,

61.26628,1.04353,

48.475,1.07053,

31.46527,1.0949,

27.70204,1.10263,

26.16111,1.10945,

25.684,1.11517,
25.47,1.11896,
25.03143,1.12463,
24.165,1.13598,
20.08429,1.2144,
14.72065,1.31403,
11.72,1.38021,
9.236535,1.45048,
3.4,1.65134,
1.8,1.69177,
\$;

After downloading the table, type in the command:

QCALT?;

This will return the number of tables currently stored in the LTC. You can use this command before and after your download to ensure your table downloaded properly.

Any modifications to the header information in the user loaded calibration table can easily be made from the LTC front panel under **Misc/View & Edit Calibration Table** selection.

You can also use the Terminal program to upload information from the LTC. If you use datalogging on the LTC, you can save the LTC's stored data to disk. Create a .txt file containing the LTC datalog queries that will retrieve the data you need. For example:

QDLB?1;QDLB?2;QDLB?3;...QDLB?148;

From the Terminal program menu, select **Transfers — Send Text File ...** and select the text file you just created. Click OK to send the contents of your text file to the LTC. Terminal will receive the responses from the LTC, which can then be copied and pasted to the

Model LTC-21 Cryogenic Temperature Controller

Windows Clipboard. Once copied to the clipboard your data can be read into another application like Excel, or another spreadsheet program.

Procedure to Transfer Datalogged data to PC using PROCOMM for DOS

LTC-21 Setup

1. Turn on LTC-21
2. Select SETUP/MISC/REMOTE INTERFACE
3. Toggle Remote I/O Selection to RS232
4. Select Baud rate -9600 is the default
5. EXIT/EXIT

Make sure the RS232 cable is connected between the PC and the LTC

On your PC, run PROCOMM from the DOS prompt.

Set up PROCOMM

ALT P - setup the line settings - 20 is for COM1, 21 is for COM2

11 is for 9600,N,8,1

ESC will come back to PROCOMM

Test the communication by entering ***OPC?**; The response should be the character:

1;

followed by a carriage return. If this doesn't happen, try a few more times. Remember, back spaces and tabs should not be used. You may need to enter:

***CLS;**

to clear the system buffers. If you are not receiving any characters from the LTC, check the cable connections, and COM port settings.

You can use PROCOMM to upload information from the LTC. If you use datalogging on the LTC, you can save the LTC's stored data to disk. Create a .txt file containing the LTC datalog queries that will retrieve the data you need. For example:

QDLB?1;QDLB?2;QDLB?3; ... QDLB?99;

Set up Log to file in PROCOMM

ALT F10 will give you all the PROCOMM choices. Select the Log Toggle ALT F1

Enter a filename where you would like to keep the datalog from the LTC.

Send file(s) over to LTC from PROCOMM

ALT F10 again, and select Receive Files by pressing Page Up key; Select 7 for ASCII

Then type in the file name of the .txt file containing the Data Log Query commands.

Watch the data coming back from the LTC, it should be in the format of

xx:xx:xx *data1 data2*

where xx:xx:xx is the time of date associated with each logged data.

Exit Procomm by pressing ALT X and Y

INDEX

A

AC Power, 10
alarm, 9, 40, 41, 67, 75, 81, 92, 104
Ambient Temperature Range, 11
Analog Output, 2, 7, 9, 13, 17, 38, 39, 63, 65, 68, 69, 109
Analog-to-Digital, 1, 48, 65
ANSI/IEEE Std 488.2-1987, 73
AUTOTUNE, 3, 7, 39, 55, 56, 57, 58, 75, 87, 90, 95, 101, 104
autotuning, 55, 56, 57, 90

B

BACKSPACE, 20
Bail, 10
baud rate, 9, 42

C

calibration curve, 45
Calibration Curves, 2, 5
calibration table, 42, 45, 46, 74, 75, 92, 93, 100
Cernox Resistors, 4
Chart Recorder, 38, 39, 51
CLEAR, 20, 48, 61, 67, 68
Contrast Adjustment, 67
CONTROL, 19, 20, 25, 27, 28, 29, 31, 33, 34, 35, 45, 46, 47, 56, 65, 90, 95
Control Mode, 27, 85
cryogenic systems, 51
cryostat, 16, 17, 18
Cubic Spline, 1
Cursor Keys, 19

D

Data log, 59
Datalog Display, 59
Datalog Setup, 59
DEC, 20, 30, 31, 32, 34, 42, 44
Digital-to-Analog, 1, 65, 69
Diode, 33, 44
Diode Sensor Connections, 108
Display - Datalog, 59

E

Enclosure, 10
ENTER, 20, 26, 27, 28, 29, 30, 35, 37, 40, 41, 46, 47, 48, 56, 59, 60, 68
Environmental, 11
Execution Error Register, 76, 91, 101
EXIT, 20, 27, 29, 30, 31, 32, 33, 35, 37, 40, 42, 45, 46, 47

F

First Time Operation, 23
function keys, 19
Fuse, 15

G

GPiB, 73, 80, 91, 92, 93, 101, 103, 104, 105
Grounding, 15
Grounding Requirements, 10

H

Heater Output, 5, 9, 13, 69, 109
heater ranges, 5, 37
Heater Wiring, 15
Humidity/Altitude, 11

I

IEEE Commands, 76, 80
IEEE Common Queries, 73
IEEE Query Commands, 78
IEEE Standard 488-1978, 9
IEEE Standard Codes, 73
IEEE-488, 2, 9, 13, 18, 19, 23, 41, 42, 65
INC, 20, 30, 31, 32, 34, 42, 44, 68, 69
Input / Output Tests Menu, 48
Input Filter Time, 31, 32, 84
Installation, 13
Instrument Calibration Menu, 48
Instrument Fusing, 10
Interface Connection, 18
interpolation, 37

K

Keyboard, 19

L

LED Test, 48
LED tests, 68
line voltage, 15
LOCAL, 19, 25, 86

M

MAX PWR, 39
Menu Tree, 20, 21
MONITOR, 19, 20, 23, 25, 26, 27, 28, 33, 45, 46, 47, 80, 96
Monitor Mode, 25, 27
Mounting, 18

N

Numeric Keypad, 20

O

Operating Modes, 25

Output Specifications, 5

P

Packing List, 13
PID coefficients, 2, 3, 7, 34, 35, 36, 38, 39, 51, 52, 55, 56
PID Table, 37, 75, 88
PID Table mode, 36
Platinum, 33, 44
Power Requirements, 14
Pwr Limit, 36, 40

R

Rack Mount Use, 10
Ramping, 40, 51, 53
Rear Panel, 9, 13, 14, 15, 17, 18, 32
Receive Buffer Overflow, 91, 101
Relay Connection, 18
Relay output connector, 10, 13
relays, 3, 9, 18, 23, 27, 30, 41, 107
Remote Control, 2, 9, 19
resolution, 1, 3, 5, 6, 8
RS-232, 2, 9, 13, 18, 19, 41, 42, 65

S

sample rate, 1, 6, 65
Sensor Cable, 13, 17
Sensor Connection, 17, 18
Sensor Input, 9, 13
serial port, 63, 65
Set point, 23, 25, 26, 27, 28, 31, 35, 41, 52, 56, 74, 75, 85, 88, 90, 99
SETUP, 19, 25, 27, 28, 29, 30, 31, 32, 33, 45, 46, 47, 57, 59
Setup - Datalog, 59
Setup Mode, 28

Size, 10

Software Revision number, 49

Standard Event Status Register,
76, 91

T

Table mode - PID Table, 36

Technical Support, ii

Transmit Buffer Overflow, 91, 101

U

Unpacking, 13

User Error Register, 91

W

WARRANTY, iii

Weight, 10